



Cessna Turbo Skylane 182

Code : SEA 327

ASSEMBLY MANUAL

“Graphics and specifications may change without notice”.



Specifications:

Wingspan----- 69 in (174.5 cm)

Overall Length----- 49.1 in (124.8 cm)

Wing Area----- 612.3 sq.in (39.5 dm²)

Flying Weight----- 3.3 kg (7.3 lbs)

Engine Size----- 46-55 (2-stroke) 52-62 (4-stroke)

10cc (Gas)

Radio----- 5 channels with 7 servos

Motor .35-.45 size 830 rev per volt/ ESC 50A/ Lipo 4s 3200mA



INTRODUCTION

Thank you for choosing the **Cessna Turbo Skylane 182** ARTF by **SG MODELS**. The **Cessna Turbo Skylane 182** was designed with the intermediate/advanced sport flyer in mind. It is a semi scale airplane which is easy to fly and quick to assemble. The airframe is conventionally built using balsa, plywood to make it stronger than the average ARTF, yet the design allows the aeroplane to be kept light. You will find that most of the work has been done for you already. The motor mount has been fitted and the hinges are pre-installed. Flying the **Cessna Turbo Skylane 182** is simply a joy.

This instruction manual is designed to help you build a great flying aeroplane. Please read this manual thoroughly before starting assembly of your **Cessna Turbo Skylane 182**. Use the parts listing below to identify all parts.

WARNING

Please be aware that this aeroplane is not a toy and if assembled or used incorrectly it is capable of causing injury to people or property. WHEN YOU FLY THIS AEROPLANE YOU ASSUME ALL RISK & RESPONSIBILITY.

If you are inexperienced with basic R/C flight we strongly recommend you contact your R/C supplier and join your local R/C model Flying Club. R/C Model Flying Clubs offer a variety of training procedures designed to help the new pilot on his way to successful R/C flight. They will also be able to advise on any insurance and safety regulations that may apply.

KIT CONTENTS

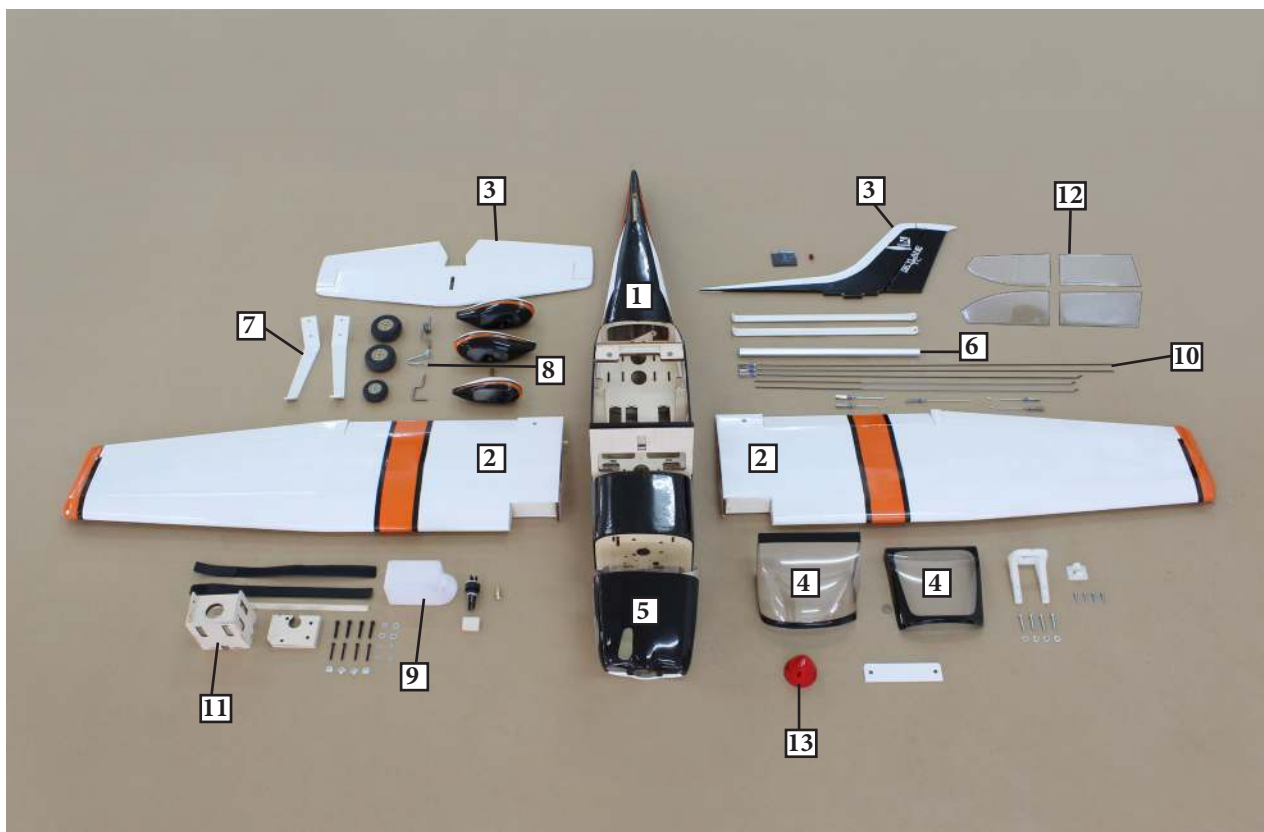

KIT CONTENTS

SEA327 Cessna Turbo Skylane 182

1. Fuselage
2. Wing set (2)
3. Tail set (2)
4. Canopy (2)
5. Cowling
6. Wing tube
7. Landing gear
8. Nose Landing gear
9. Fuel tank
10. Pushrod set
11. Ep Motor box
12. Windows
13. Spinner

ADDITIONAL ITEMS REQUIRED

- 10cc gasoline engine.
- Computer radio 5 channel with 7 servos.
- Glow plug to suit engine.
- Propeller to suit engine.
- Protective foam rubber for radio system.

TOOLS & SUPPLIES NEEDED

- Thin cyanoacrylate glue.
- Medium cyanoacrylate glue.
- 30 minute epoxy.
- 5 minute epoxy.
- Hand or electric drill.
- Assorted drill bits.
- Modelling knife.
- Straight edge ruler.
- 2mm ball driver.
- Phillips head screwdriver.
- 220 grit sandpaper.
- 90° square or builder's triangle.
- Wire cutters.
- Masking tape & T-pins.
- Thread-lock.
- Paper towels.

HINGING THE FLAP

Note: The control surfaces, including the ailerons, elevators, and rudder, are prehinged with hinges installed, but the hinges are not glued in place. It is imperative that you properly adhere the hinges in place per the steps that follow using a high-quality thin C/A glue.

- Carefully remove the flap from one of the wing panels. Note the position of the hinges.

1.

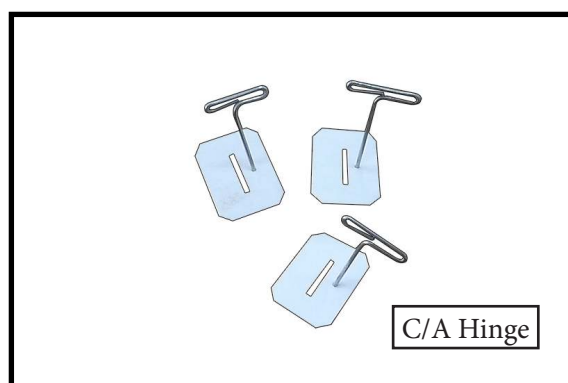

- Remove each hinge from the wing panel and flap and place a T-pin in the center of each hinge. Slide each hinge into the aileron until the T-pin is snug against the aileron. This will help ensure an equal amount of hinge is on either side of the hinge line when the flap is mounted to the wing panel.

2.

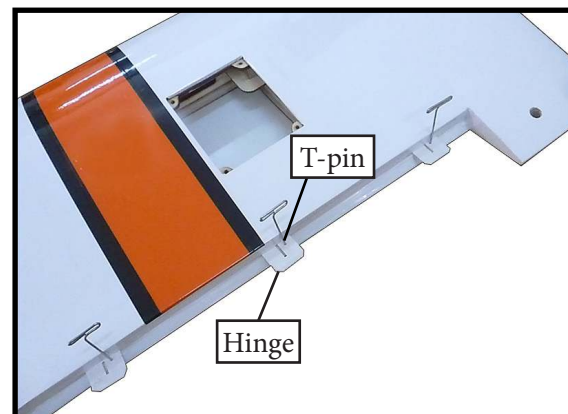

- Slide the wing panel on the flap until there is only a slight gap. The hinge is now centered on the wing panel and flap. Remove the T-pins and snug the aileron against the wing panel. A gap of 1/64" or less should be maintained between the wing panel and flap.

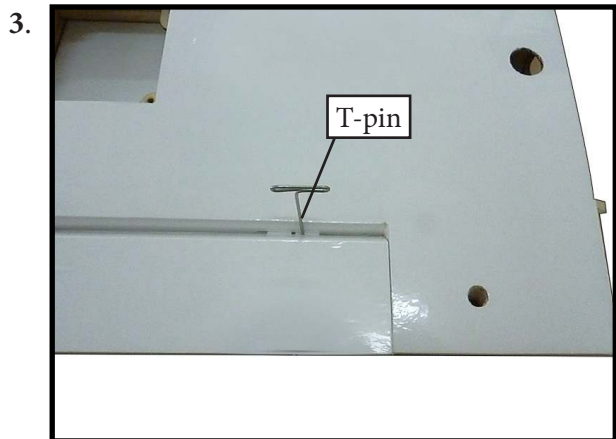

- Deflect the flap and completely saturate each hinge with thin C/A glue. The ailerons front surface should lightly contact the wing during this procedure. Ideally, when the hinges are glued in place, a 1/64" gap or less will be maintained throughout the length of the flap to the wing panel hinge line.

NOTE : The hinge is constructed of a special material that allows the C/A to wick or penetrate and distribute throughout the hinge, securely bonding it to the wood structure of the wing panel and flap.



- Turn the wing panel over and deflect the flap in the opposite direction from the opposite side. Apply thin C/A glue to each hinge, making sure that the C/A penetrates into both the aileron and wing panel.

- Using C/A remover/debonder and a paper towel, remove any excess C/A glue that may have accumulated on the wing or in the flap hinge area.

- Repeat this process with the other wing panel, securely hinging the aileron in place.

- After both flap are securely hinged, firmly grasp the wing panel and aileron to make sure the hinges are securely glued and cannot be pulled out. Do this by carefully applying medium pressure, trying to separate the flap from the wing panel. Use caution not to crush the wing structure.

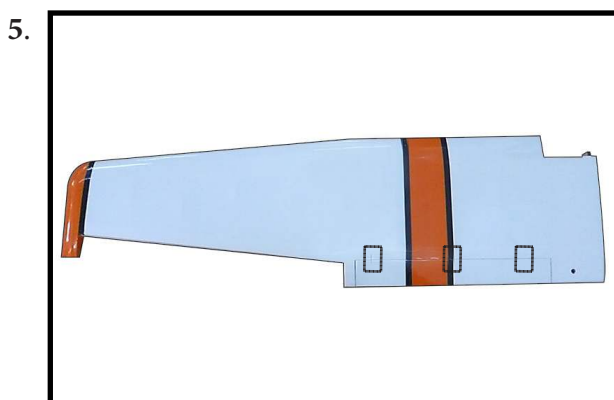

Note : Work the aileron up and down several times to "work in" the hinges and check for proper movement.

HINGING THE AILERON

Note : *The control surfaces, including the ailerons, elevators, and rudder, are prehinged with hinges installed, but the hinges are not glued in place. It is imperative that you properly adhere the hinges in place per the steps that follow using a high-quality thin C/A glue.*

- Carefully remove the aileron from one of the wing panels. Note the position of the hinges.

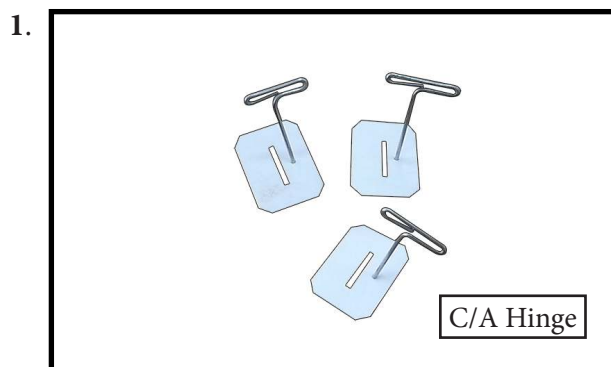

- Remove each hinge from the wing panel and aileron and place a T-pin in the center of each hinge. Slide each hinge into the wing panel until the T-pin is snug against the wing panel. This will help ensure an equal amount of hinge is on either side of the hinge line when the aileron is mounted to the aileron.

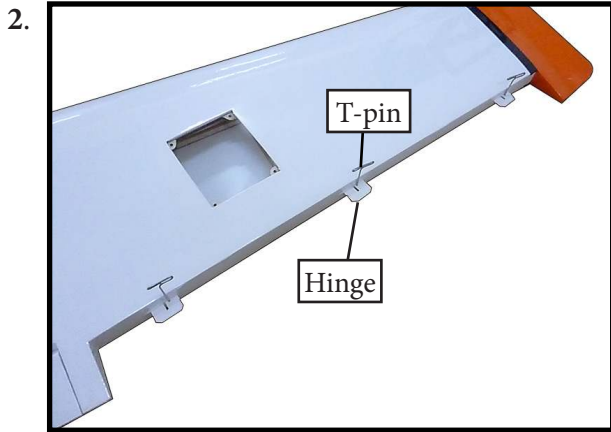

- Slide the wing panel on the aileron until there is only a slight gap. The hinge is now centered on the wing panel and aileron. Remove the T-pins and snug the aileron against the wing panel. A gap of 1/64" or less should be maintained between the wing panel and aileron.



- Deflect the aileron and completely saturate each hinge with thin C/A glue. The ailerons front surface should lightly contact the wing during this procedure. Ideally, when the hinges are glued in place, a 1/64" gap or less will be maintained throughout the length of the aileron to the wing panel hinge line.

NOTE : The hinge is constructed of a special material that allows the C/A to wick or penetrate and distribute throughout the hinge, securely bonding it to the wood structure of the wing panel and aileron.

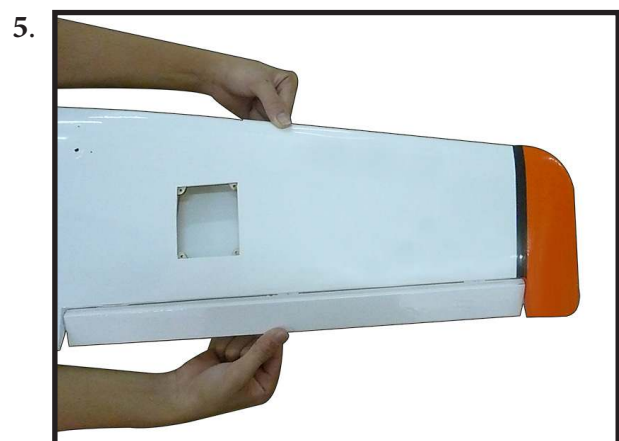
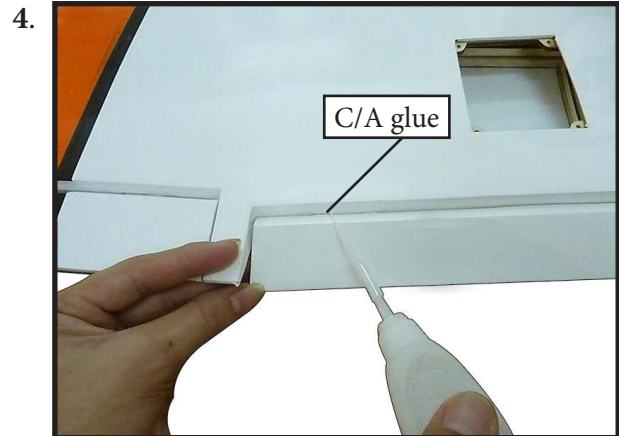

- Turn the wing panel over and deflect the aileron in the opposite direction from the opposite side. Apply thin C/A glue to each hinge, making sure that the C/A penetrates into both the aileron and wing panel.
- Using C/A remover/debonder and a paper towel, remove any excess C/A glue that may have accumulated on the wing or in the aileron hinge area.
- Repeat this process with the other wing panel, securely hinging the aileron in place.
- After both ailerons are securely hinged, firmly grasp the wing panel and aileron to make sure the hinges are securely glued and cannot be pulled out. Do this by carefully applying medium pressure, trying to separate the aileron from the wing panel. Use caution not to crush the wing structure.

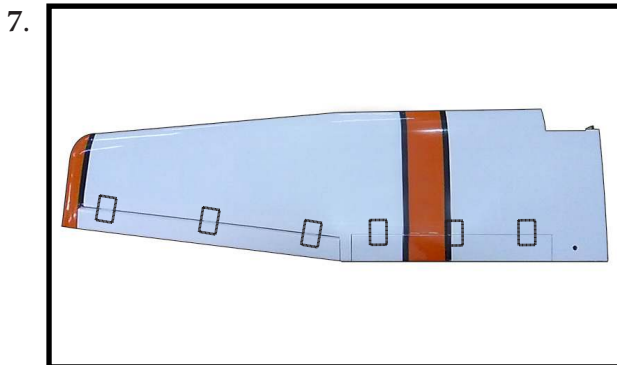

Note : Work the aileron up and down several times to “work in” the hinges and check for proper movement.

INSTALL THE AILERONS CONTROL HORN

INSTALL FLAP CONTROL HORN

- Install the flap control horn using the same method as same as the aileron control horns.



2.



Minimum servo spec.
Torque : 66.6 oz-in (4.8 kg-cm) @ 4.8V;
 83.3 oz-in (6.0 kg-cm) @ 6.0V

! Because the size of servos differ, you may need to adjust the size of the precut opening in the mount. The notch in the sides of the mount allow the servo lead to pass through.

INSTALLING THE AILERON SERVOS

1.

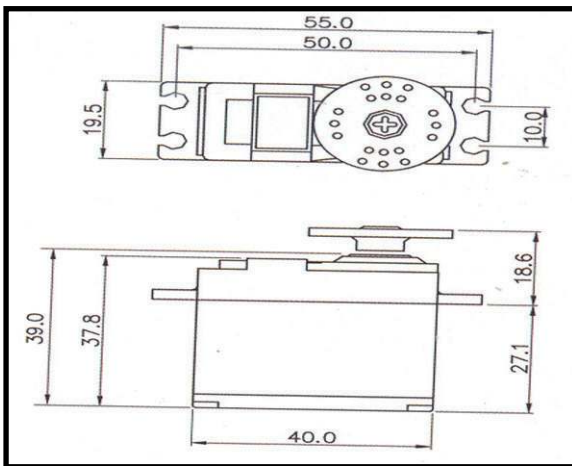

- Place the servo between the mounting blocks and space it from the hatch. Use a pencil to mark the mounting hole locations on the blocks.

3.

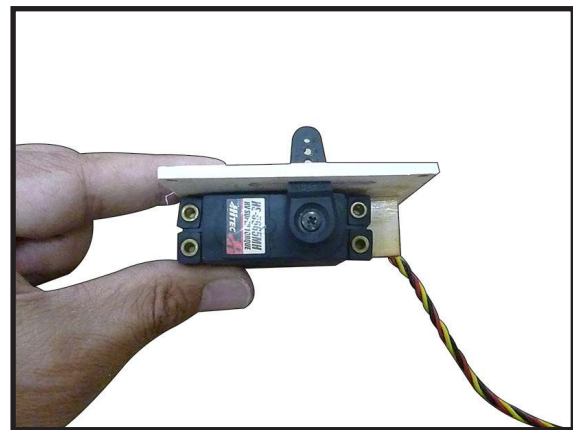

- Use drill bit in a pin vise to drill the mounting holes in the blocks.

2.

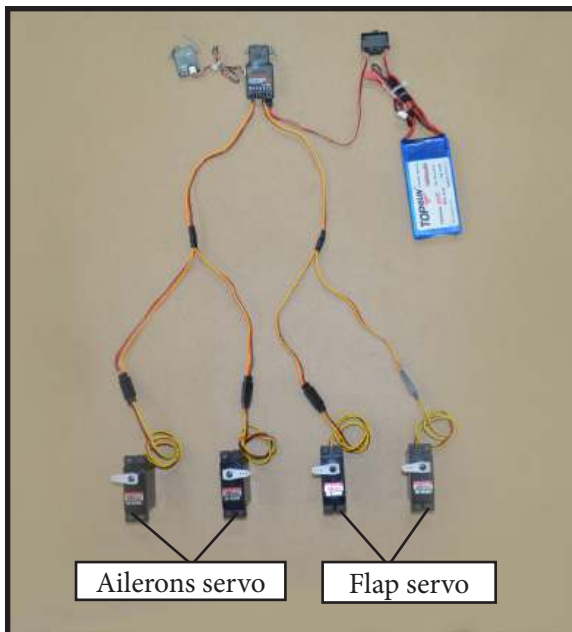

4.

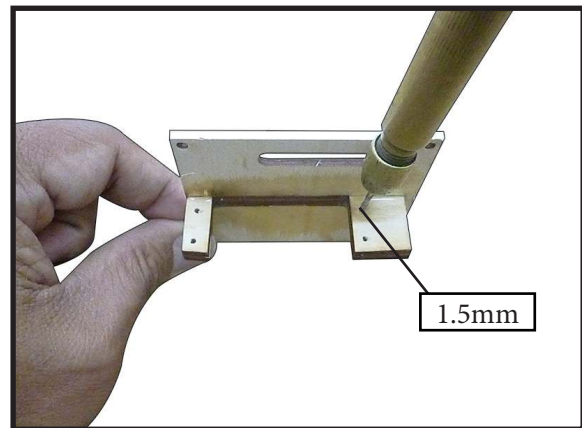

- Apply 2-3 drops of thin C/A to each of the mounting holes. Allow the C/A to cure without using accelerator.

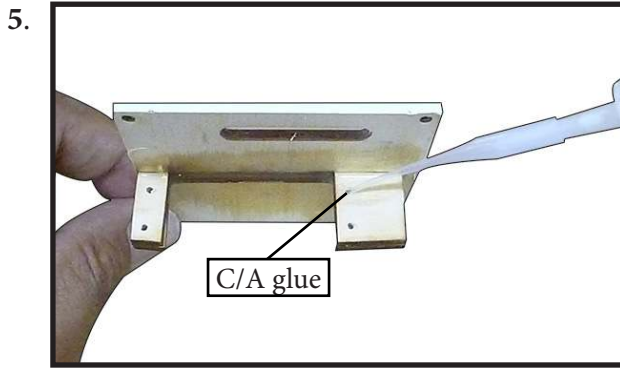

- Use dental floss or heatshrink tube to secure the connection so they cannot become unplugged.

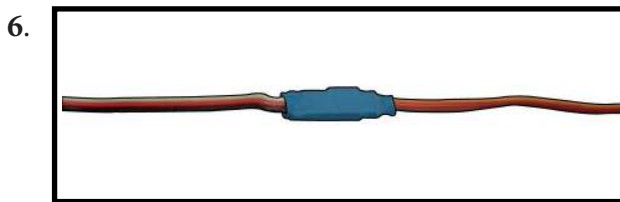

- Secure the servo to the aileron hatch using Phillips screwdriver and the screws provided with the servo.



- Apply 1-2 drops of thin C/A to each of the mounting tabs. Allow the C/A to cure without using accelerator.

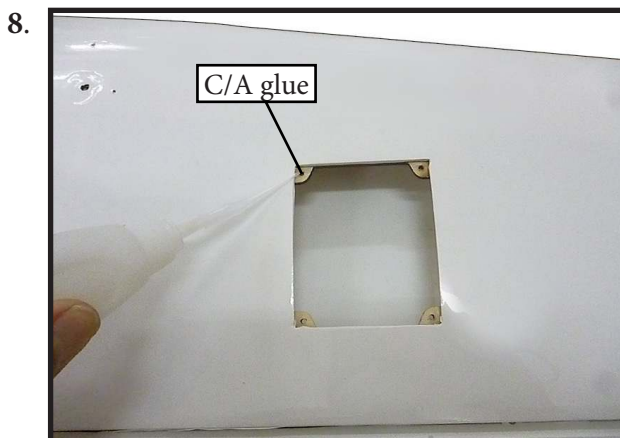

- Remove the string from the wing at the servo location and use the tape to attach it to the servo extension lead. Pull the lead through the wing and remove the string.

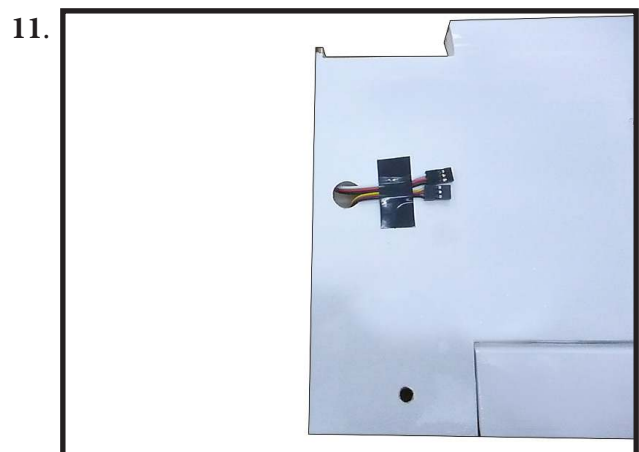
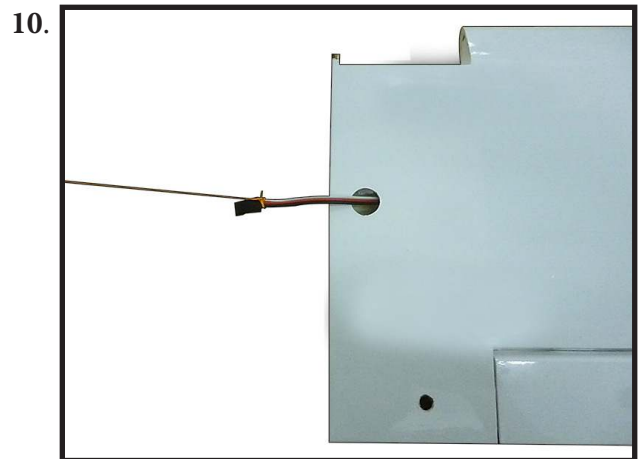
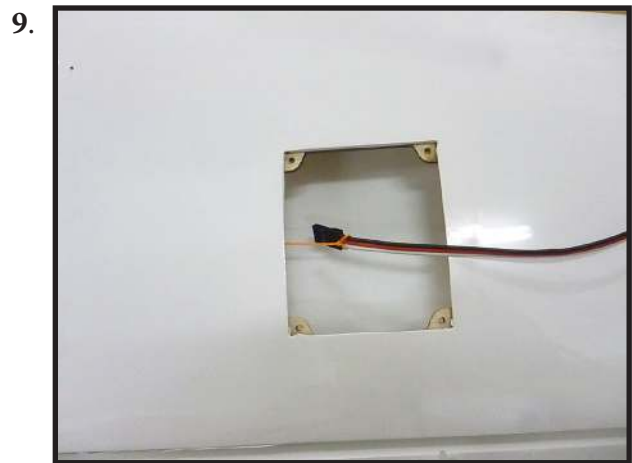



- Set the aileron hatch in place and use a Phillips screw driver to install it with four wood screws.

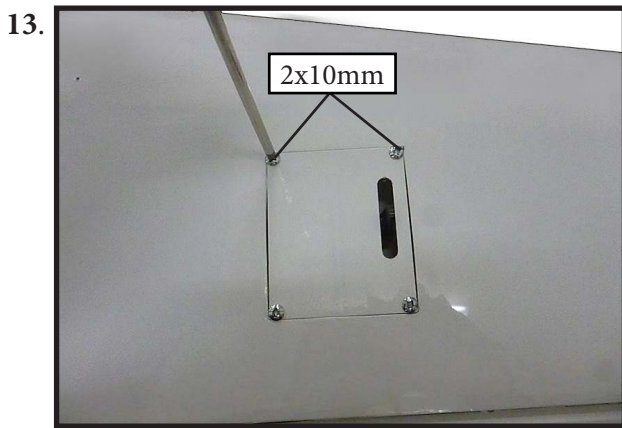
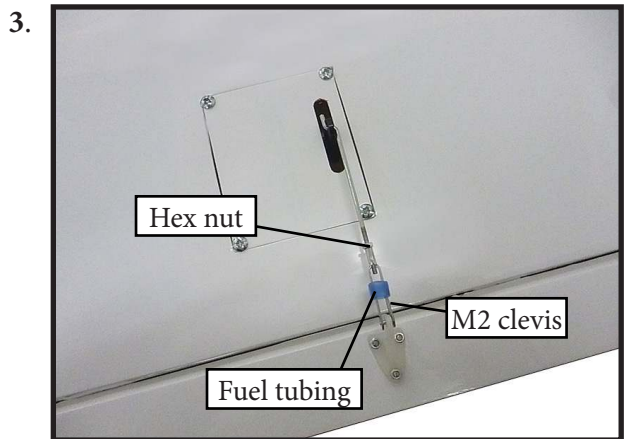

INSTALLING THE FLAP PUSHROD

- Repeat the procedure for the aileron pushrod.

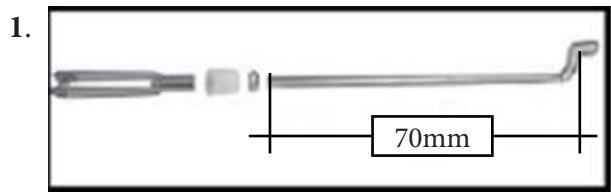

AILERON PUSHROD INSTALLATION

- Please see below pictures.

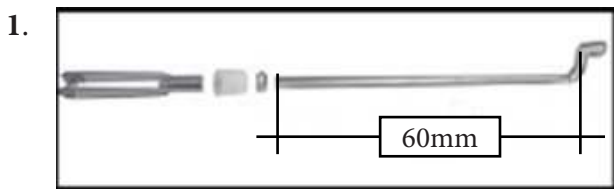

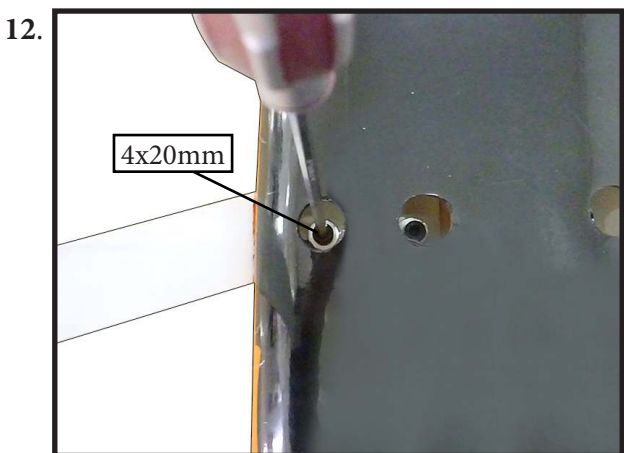
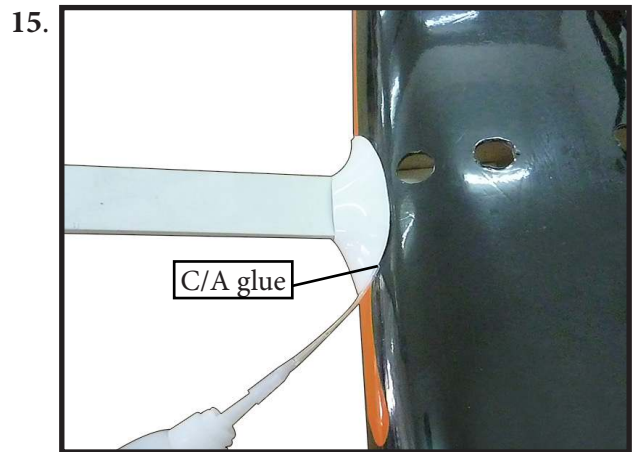
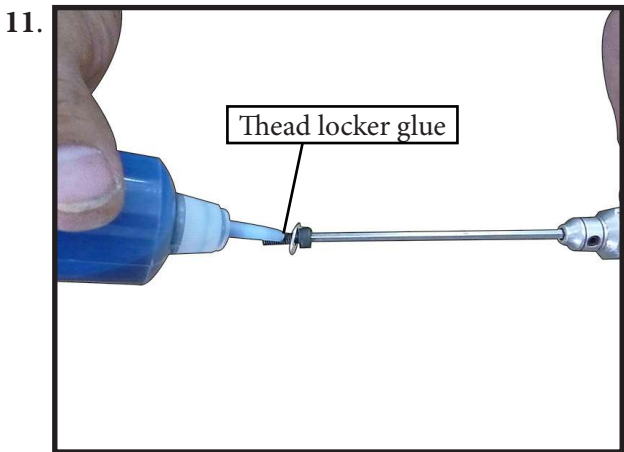
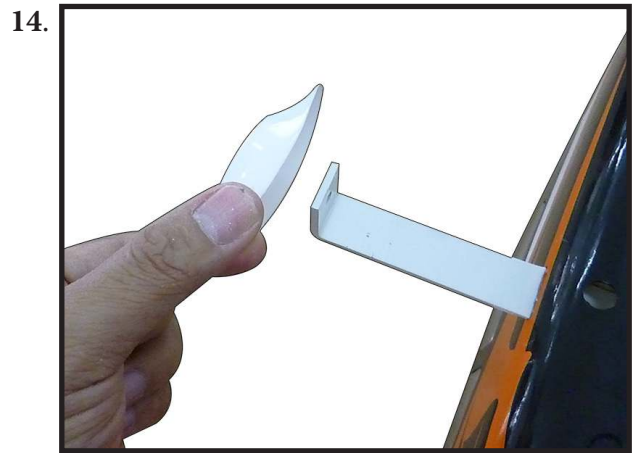

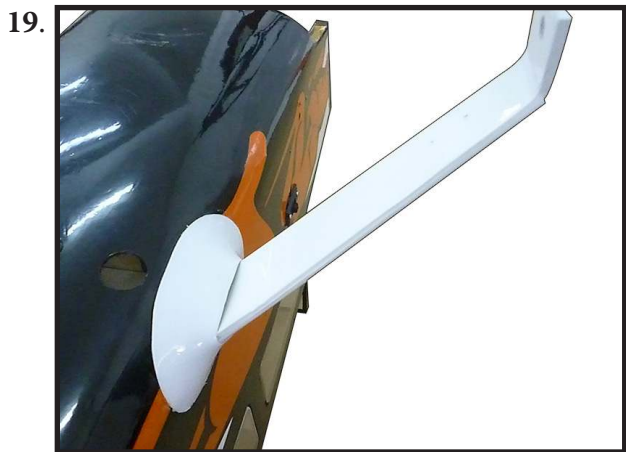
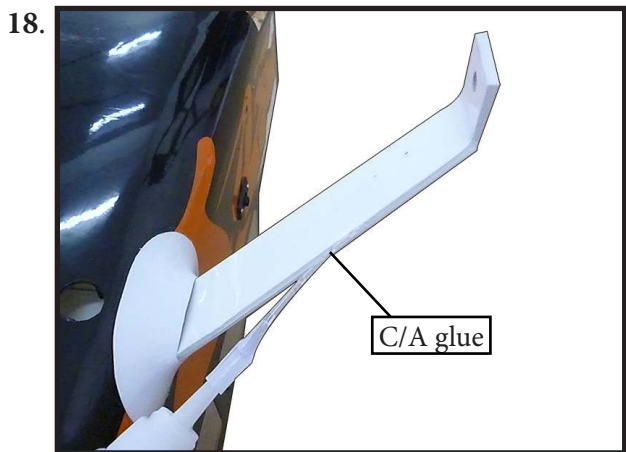

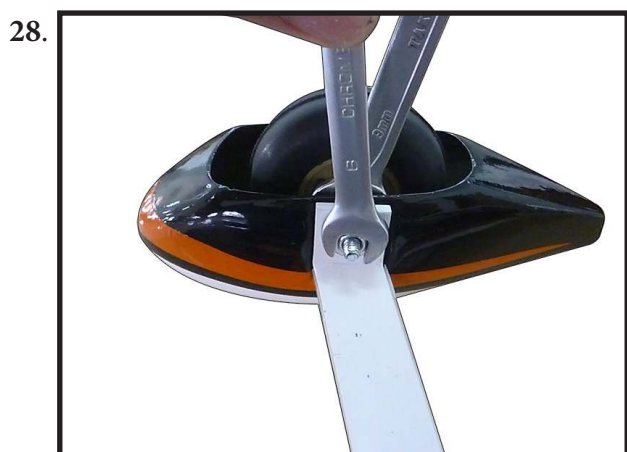

INSTALL NOSE GEAR

- Locate the items necessary to attach the nose landing gear that are included with your model.

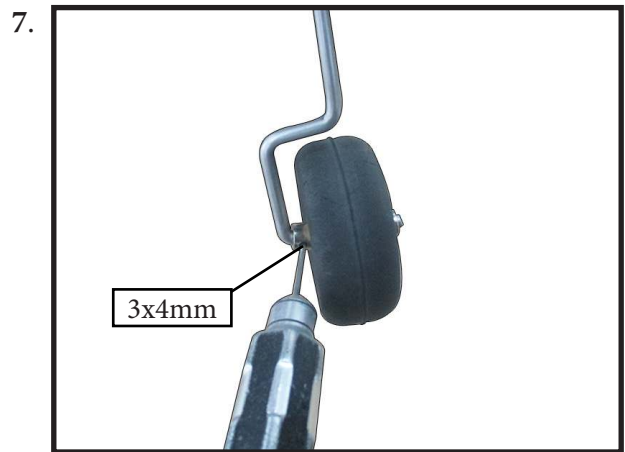
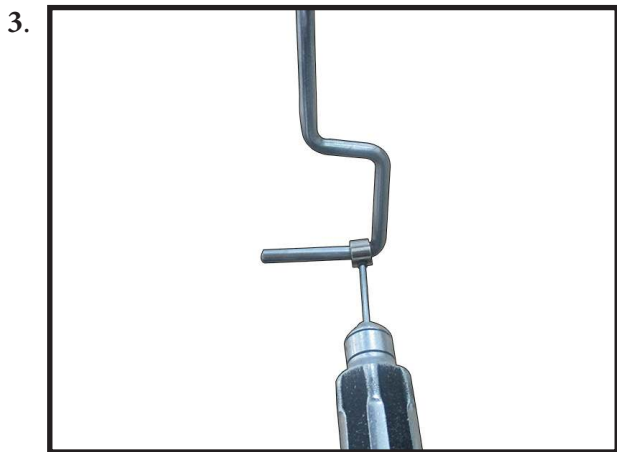
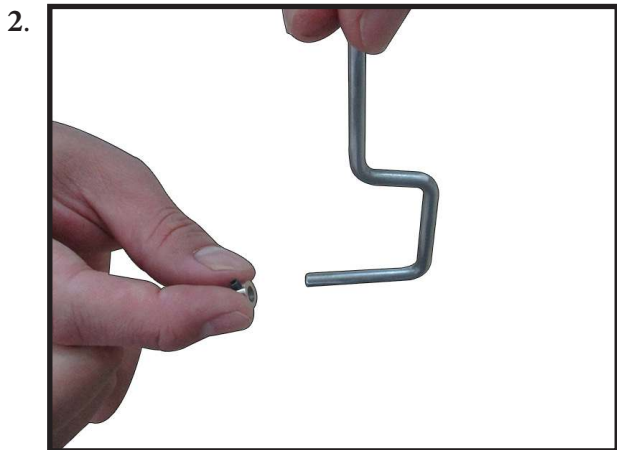
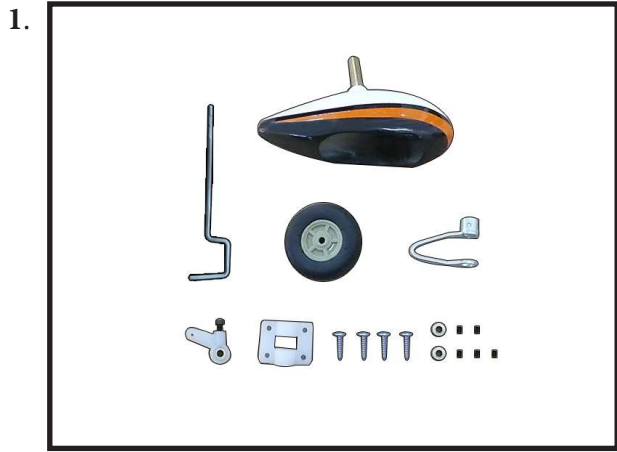

9.



13.

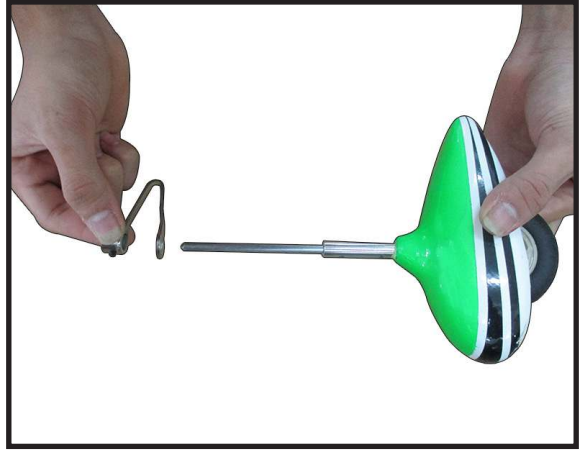

10.



14.



11.



15.

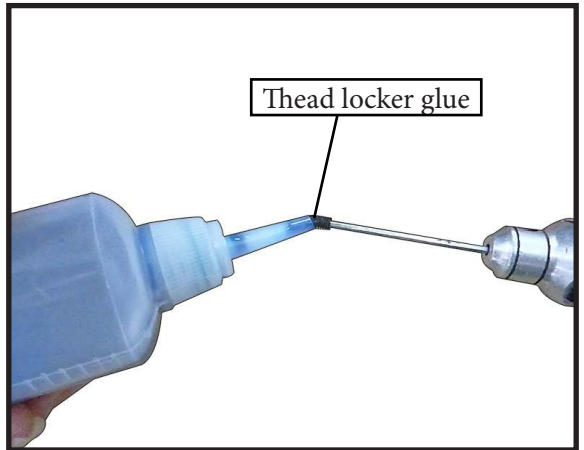

12.



16.



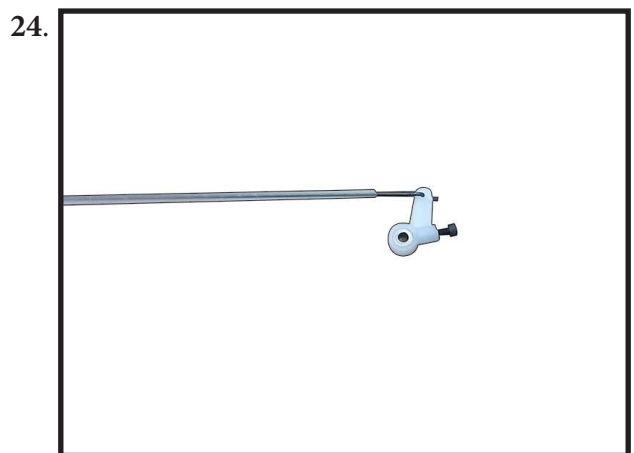
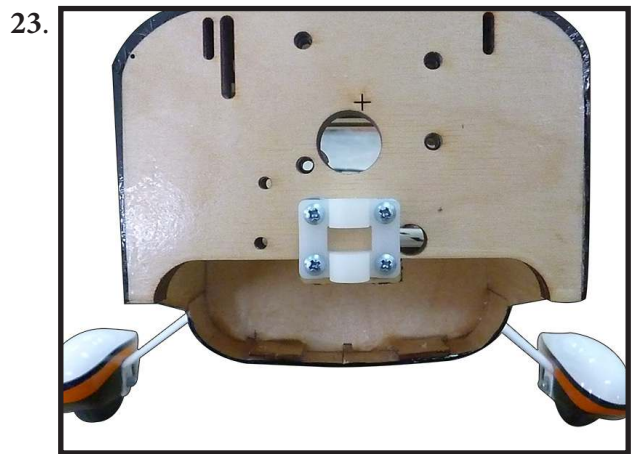
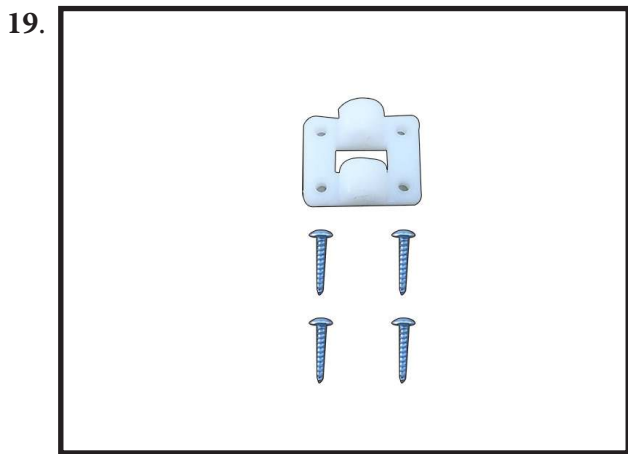
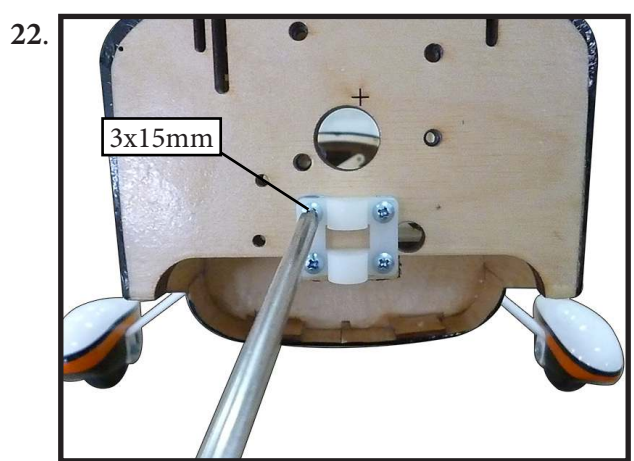
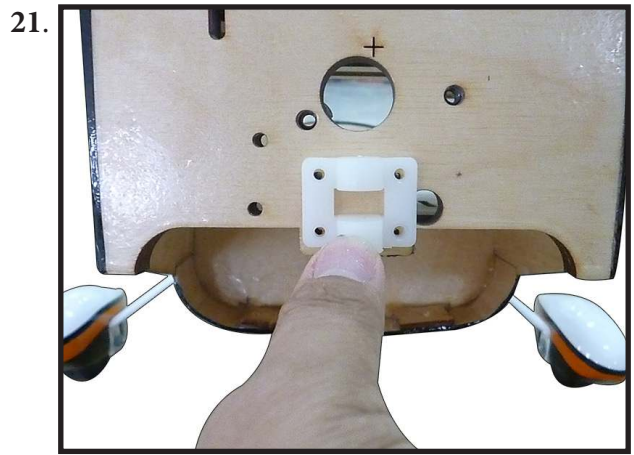

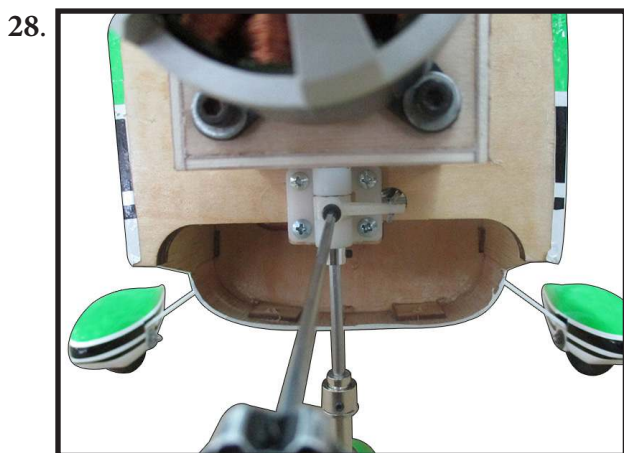
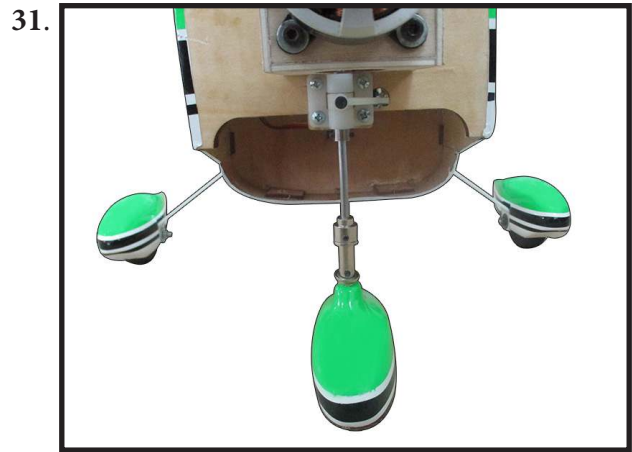
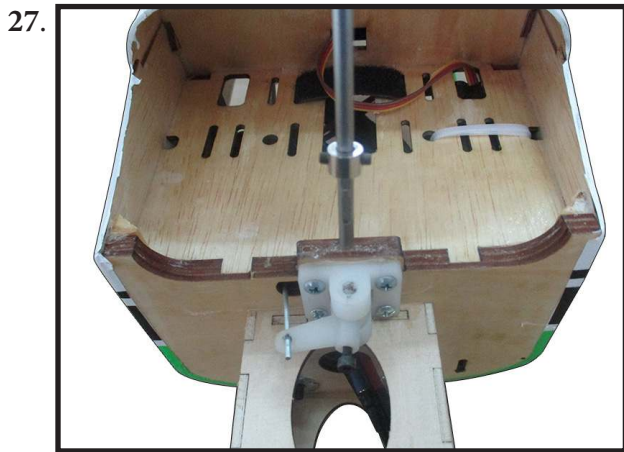
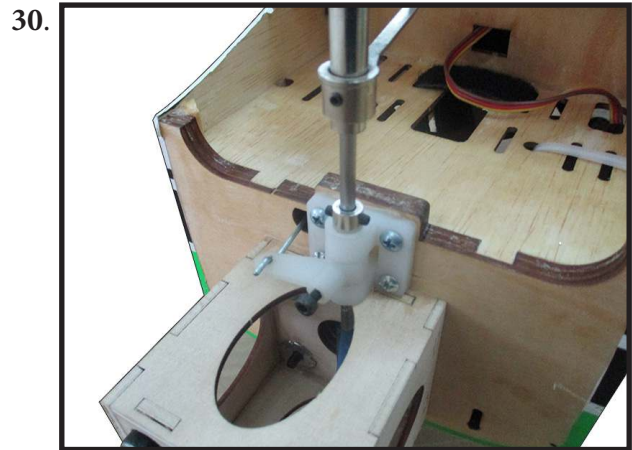
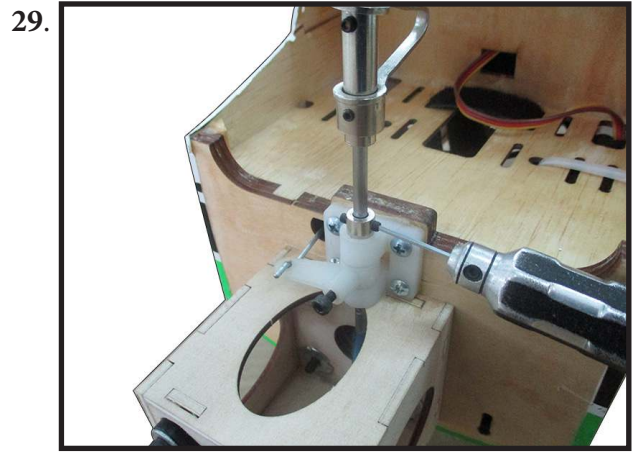
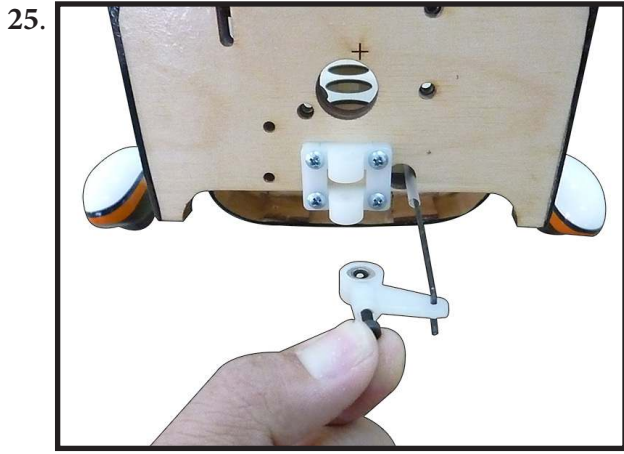

INSTALLING THE FUSELAGE SERVOS

! Because the size of servos differ, you may need to adjust the size of the precut opening in the mount. The notch in the sides of the mount allow the servo lead to pass through.

- Install the rubber grommets and brass collets into all servos. Test fit the servos into the fuselage servo mounts.

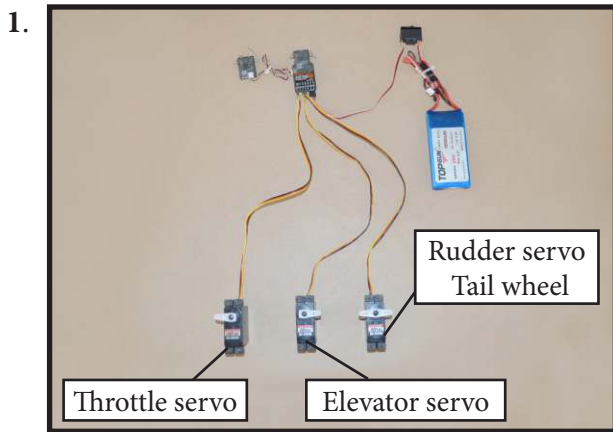

- Secure the servos with the screws provided with your radio system.

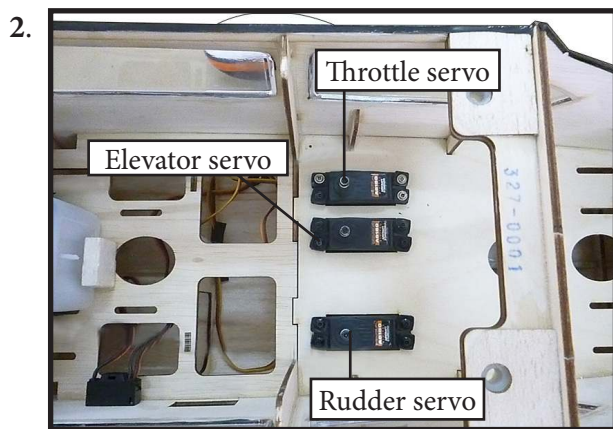

THROTTLE SERVO ARM INSTALLATION

- Install adjustable servo connector in the servo arm as same as picture below:

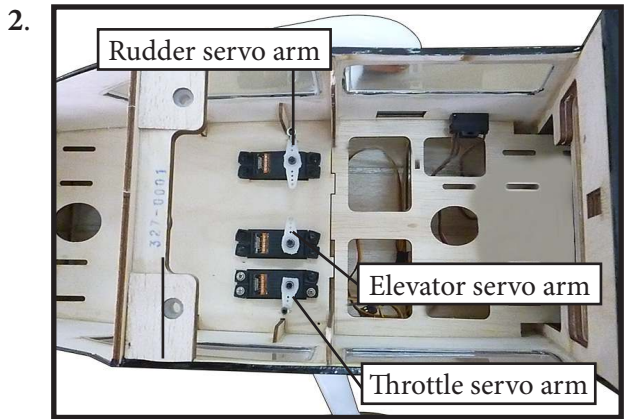
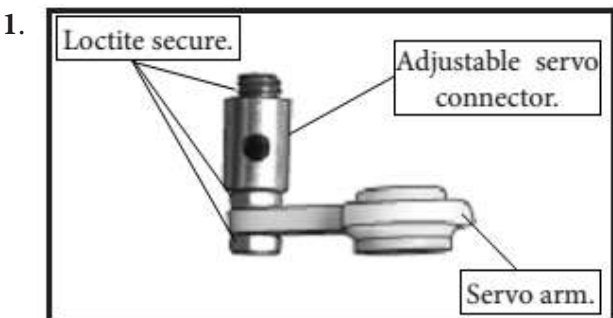

INSTALLING THE RECEIVER SWITCH

- Install the switch into the precut hole in the side, in the fuselage.

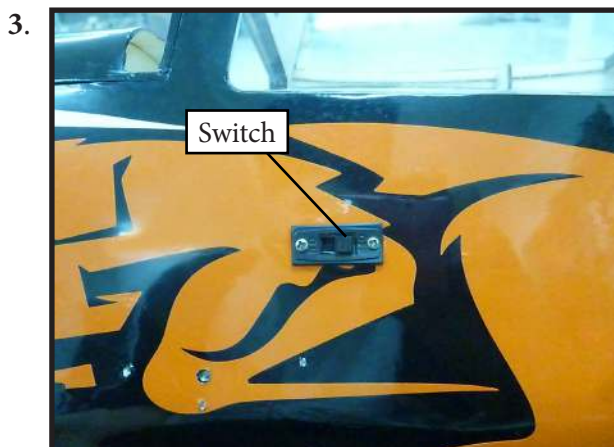
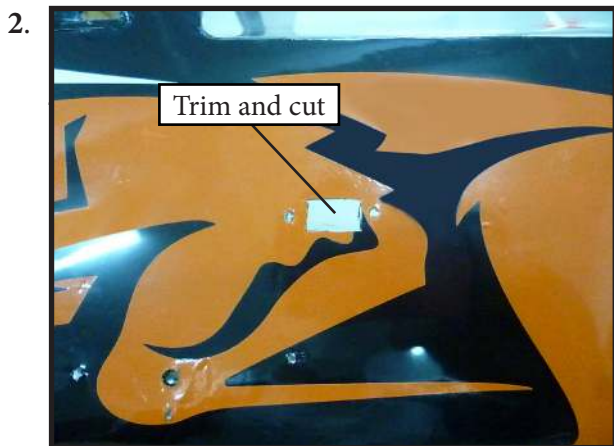
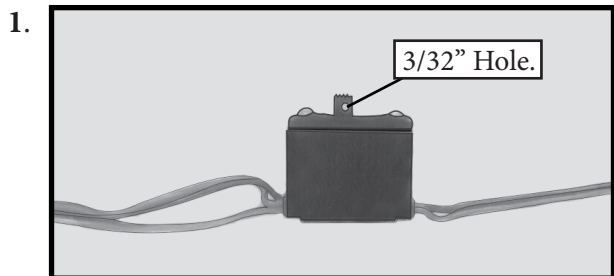

INSTALLING THE STOPPER ASSEMBLY

- Using a modeling knife, carefully cut off the rear portion of one of the 3 nylon tubes leaving 1/2" protruding from the rear of the stopper. This will be the fuel pick up tube.
- Using a modeling knife, cut one length of silicon fuel line. Connect one end of the line to the weighted fuel pick up and the other end to the nylon pick up tube.

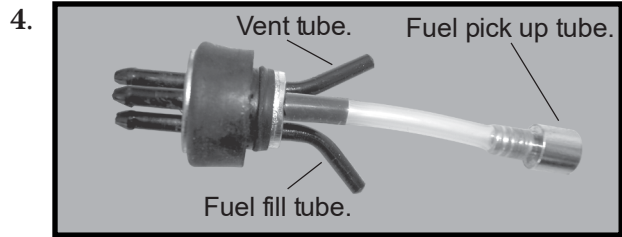
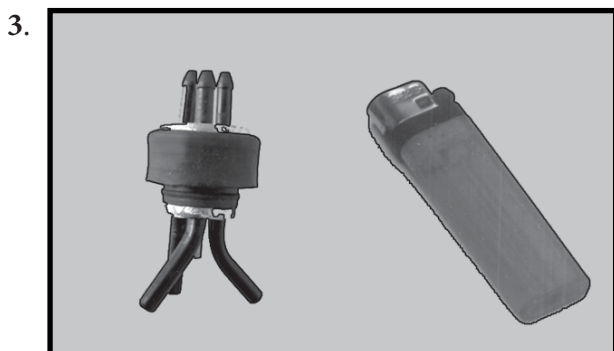
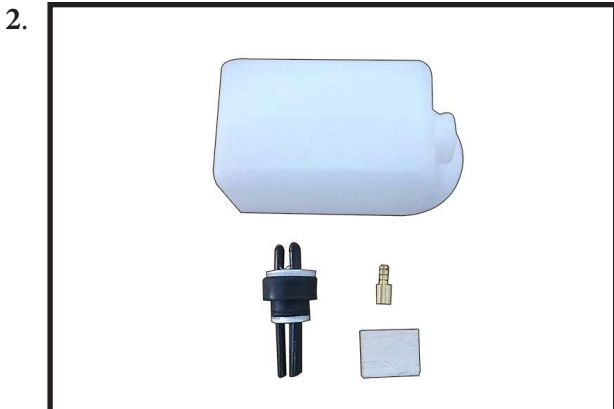
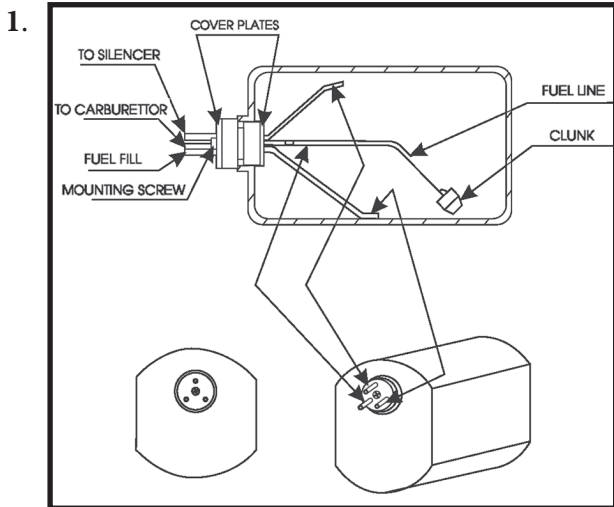

- Carefully bend the second nylon tube up at a 45° angle. This tube is the vent tube.
- Test fit the stopper assembly into the tank. It may be necessary to remove some of the flashing around the tank opening using a modeling knife. If flashing is present, make sure none falls into the tank.
- With the stopper assembly in place, the weighted pick-up should rest away from the rear of the tank and move freely inside the tank. The top of the vent tube should rest just below the top of the tank. It should not touch the top of the tank.
- When satisfied with the alignment of the stopper assembly tighten the 3 x 20mm machine screw until the rubber stopper expands and seals the tank opening. Do not over-tighten the assembly as this could cause the tank to split.

FUEL TANK INSTALLATION

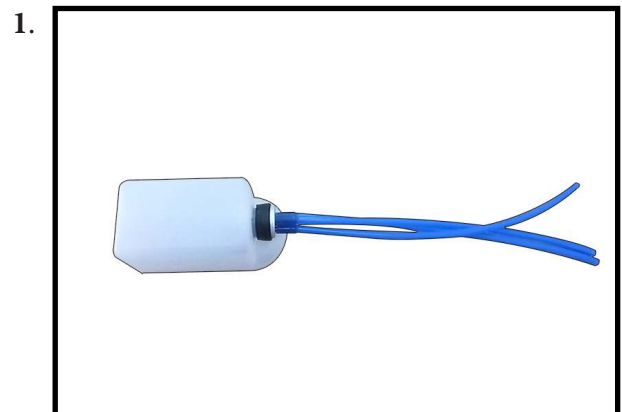

-  You should mark which tube is the vent and which is the fuel pickup when you attach fuel tubing to the tubes in the stopper. Once the tank is installed inside the fuselage, it may be difficult to determine which is which.

- Slide the fuel tank into the fuselage. Guide the lines from the tank through the hole in the firewall.
- Use plywood template to hold in place the fuel tank with C/A glue to secure the fuel tank inside the fuselage.

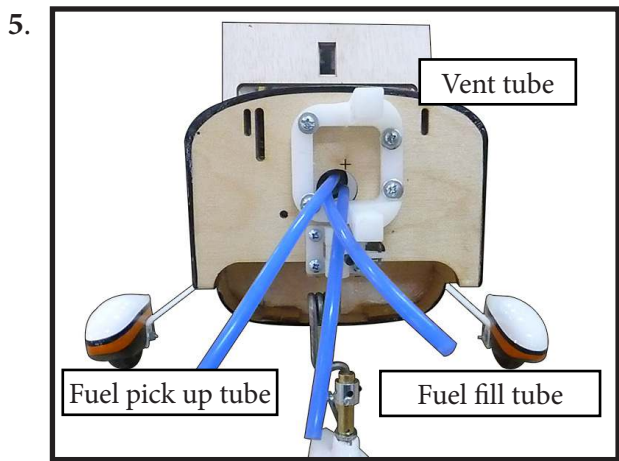
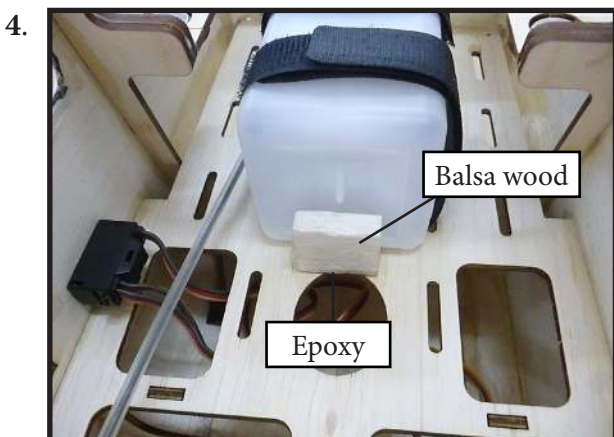
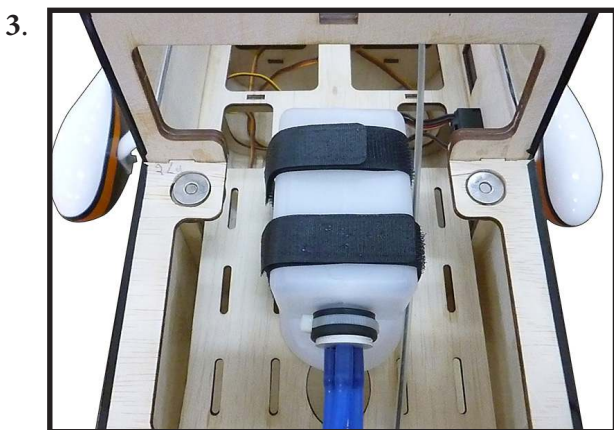
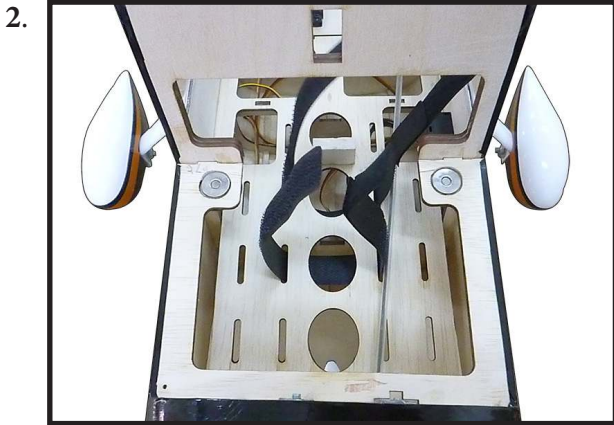

- Connect the lines from the tank to the engine and muffler. The vent line will connect to the muffler and the line from the clunk to the carburetor.

! *Blow through one of the lines to ensure the fuel lines have not become kinked inside the fuel tank compartment. Air should flow through easily.*

MOUNTING THE ENGINE

- Position the engine with the drive washer (125mm) forward of the firewall as shown.

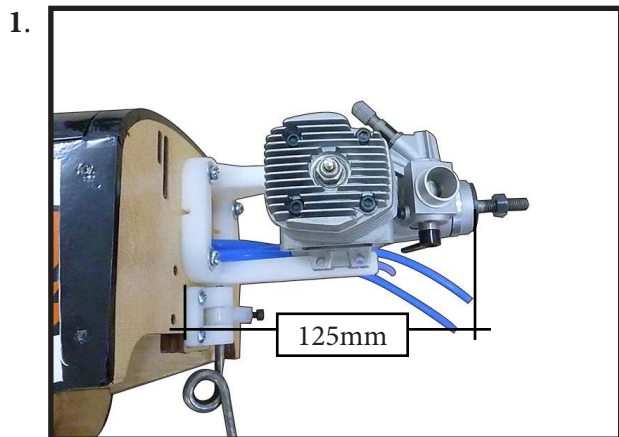

- Use a pin drill and 4mm drill bit to drill a small indentation in the mount for the engine mounting screw.

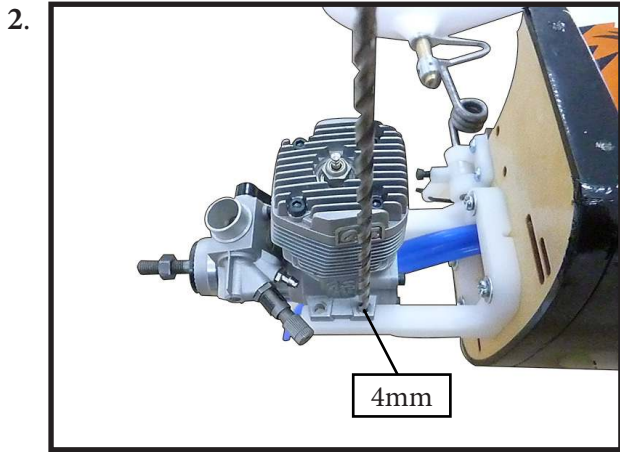

- Use a drill to drill the four holes in the engine mount rails.

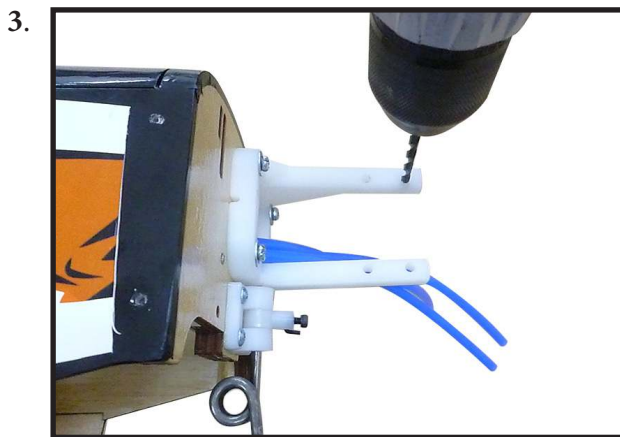

- On the fire wall has the location for the throttle pushrod tube (pre-drill).

- Slide the pushrod tube in the fire wall and guide it through the fuel tank mount. Use medium C/A to glue the tube to the fire wall and the fuel tank mount.

- Connect the Z-bend in the 450mm throttle pushrod to the outer hole of the carburetor arm.

- Slide the throttle pushrod wire into the tube. Position the engine between the mounts. Use four M4x30mm machine screws to secure the engine to the mount as shown.

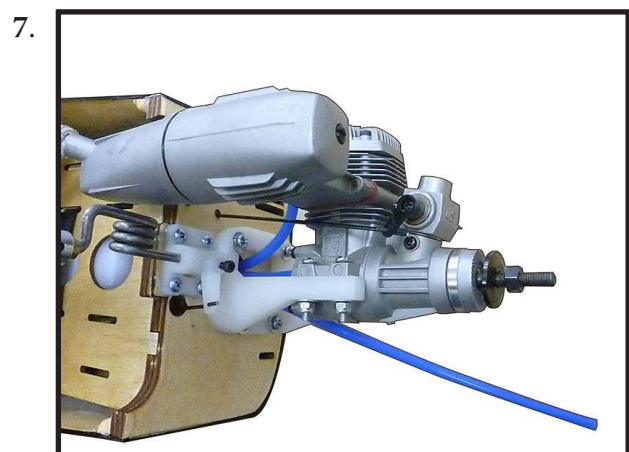
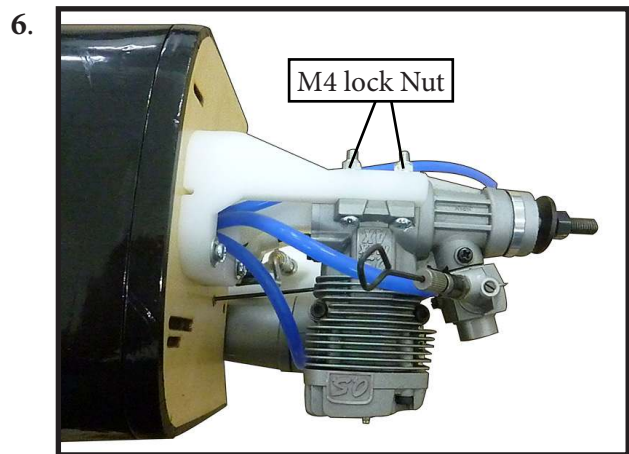
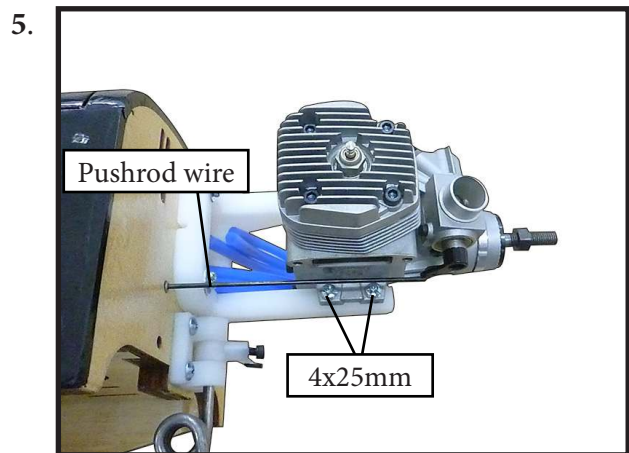
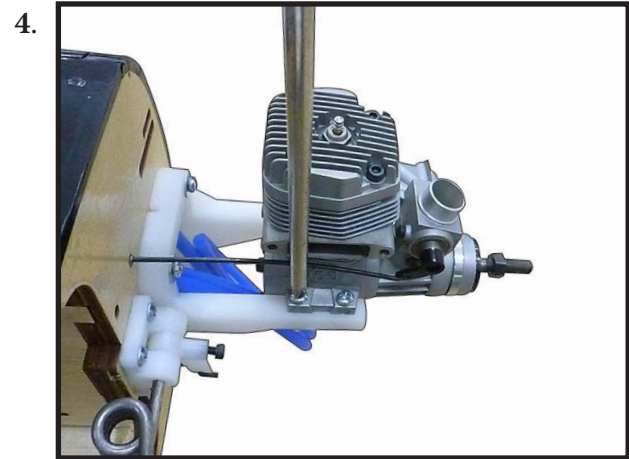

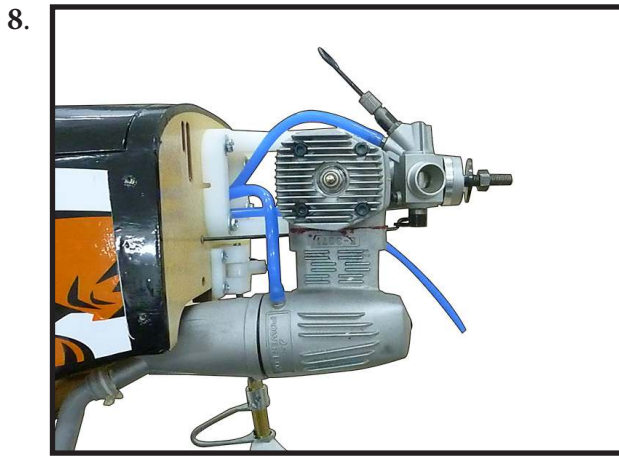

- Reinstall the servo horn by sliding the connector over the pushrod wire. Center the throttle stick and trim and install the servo horn perpendicular to the servo center line.



- Move the throttle stick to the closed position and move the carburetor to closed. Use a 2.5mm hex wrench to tighten the screw that secures the throttle pushrod wire. Make sure to use threadlock on the screw so it does not vibrate loose.



COWLING

- Please see below pictures.



- Tape the cowl to the fuselage using low-tack tape.



- Use a drill and drill bit to drill the holes for the cowl mounting screws. Make sure the cowl position is correct before drilling each hole.

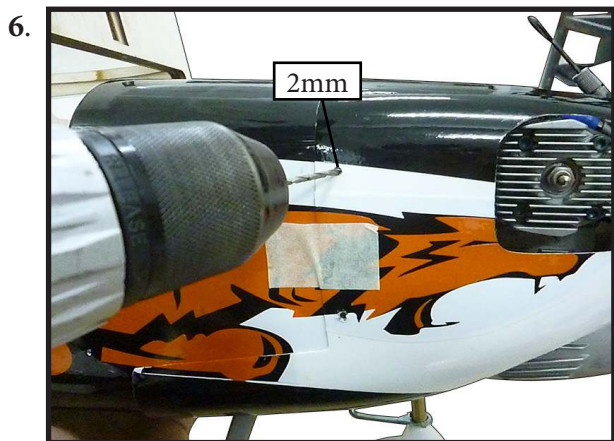

- Install the muffler and muffler extension onto the engine and make the cutout in the cowl for muffler clearance. Connect the fuel and pressure lines to the carburetor, muffler and fuel filter valve. Secure the cowl to fuselage using the M3x10mm socket head screws. Putting a small length of silicon fuel tube under the head of the screw helps with vibration.

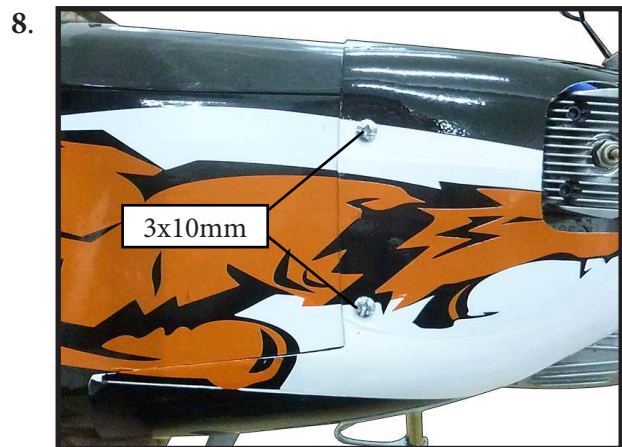



- **Motor: 35-45 (830 Watt)**
- **ESC: 50A**
- **Lipo Batteries: 4S 3200mA**

- Attach the electric motor box to the firewall centered with the cross lines drawn on the electric motor box and firewall. Using M4x25mm to secure the motor box to the firewall. Please see pictures below.

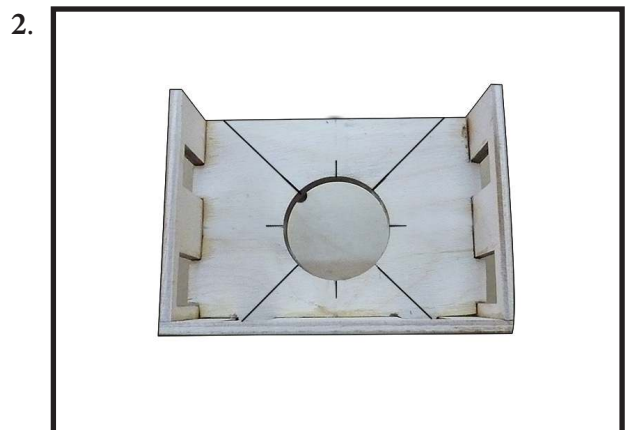

ELECTRIC POWER CONVERSION

- Locate the items necessary to install the electric power conversion included with your model.

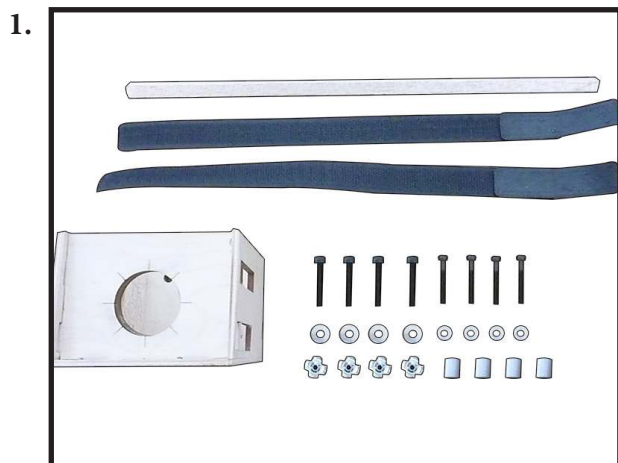

- Recommend the items necessary to install the electric power conversion parts included with your model.



- Attach the motor mount to the front of the electric motor box using four 4mm blind nut, four M4x25mm hex head bolts to secure the motor. Please see picture shown.

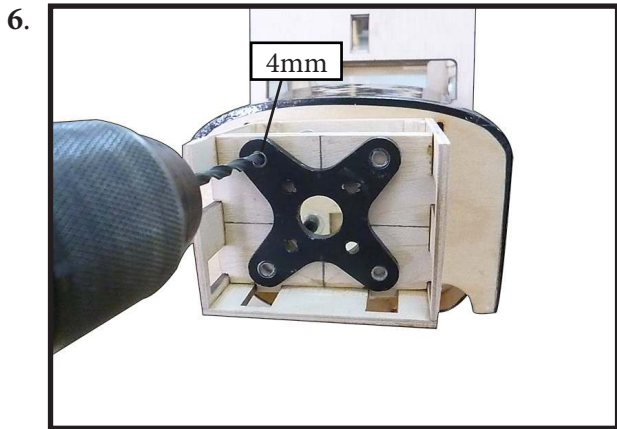
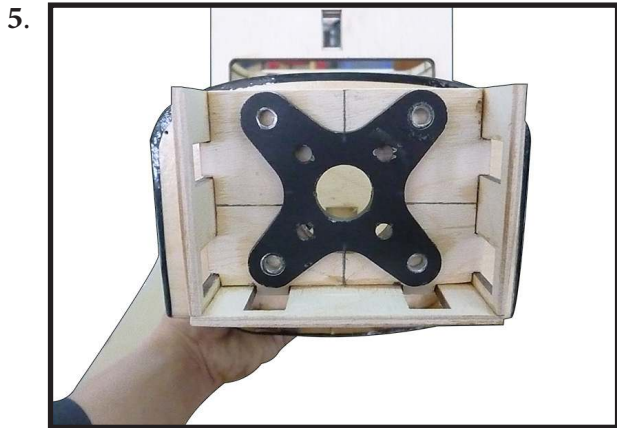
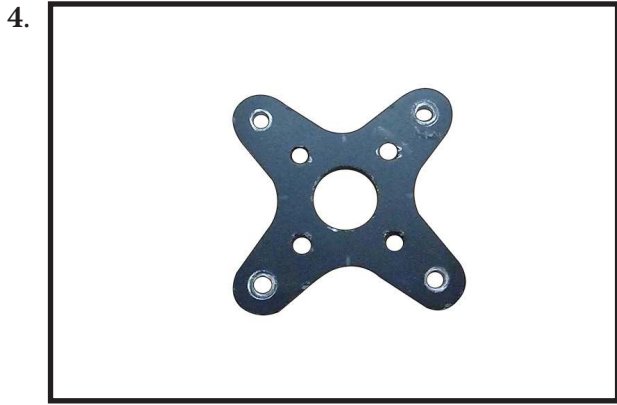

- Then, use 4mm drill bit to enlarge the holes on the electric motor box.



- Attach the motor to the front of the electric motor box using four 4mm blind nut, four M3x15mm hex head bolts to secure the motor. Please see picture shown.

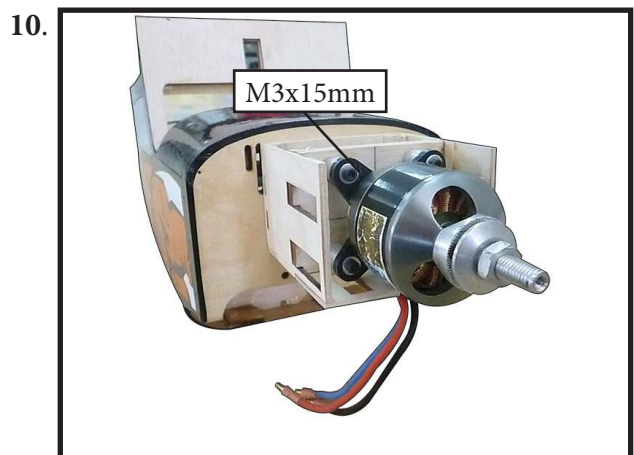
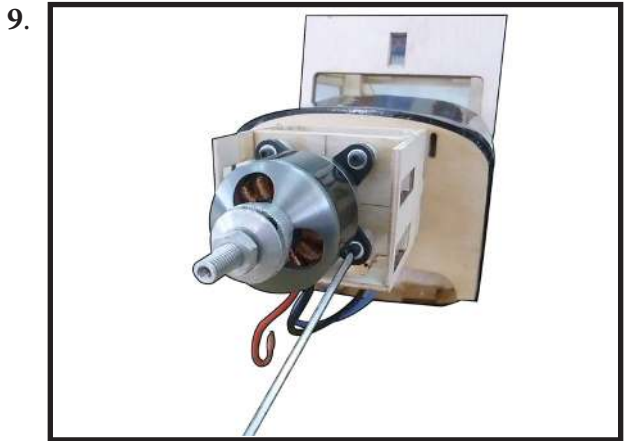

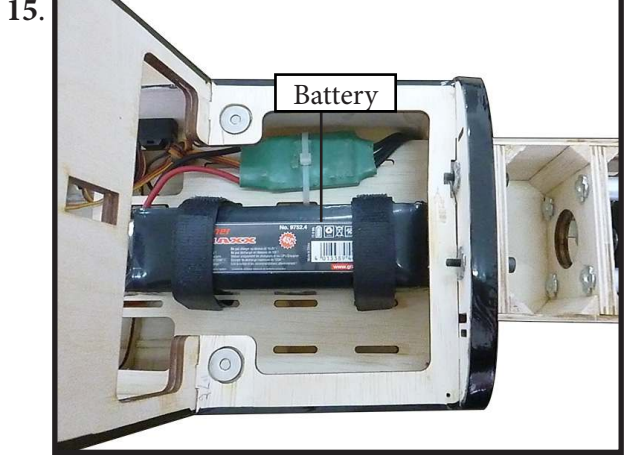
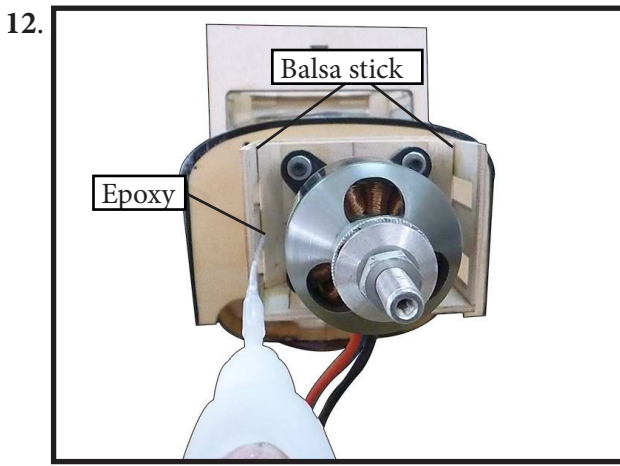
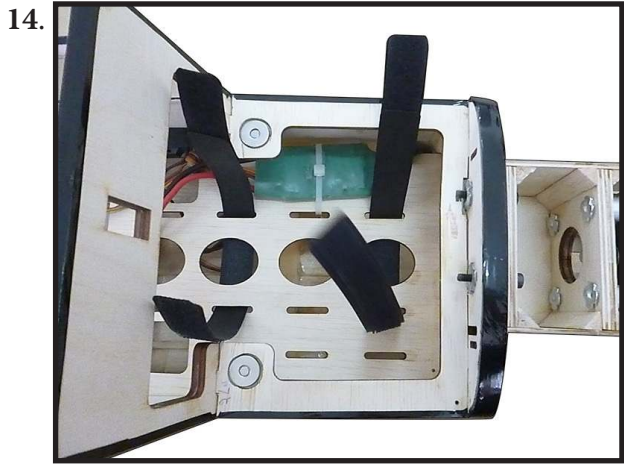
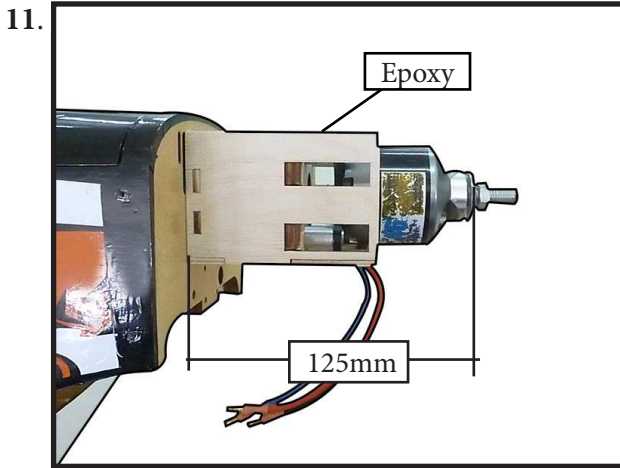

- Attach the speed control to the side of the motor box using two-sided tape and tie wraps. Connect the appropriate leads from the speed control to the motor. Make sure the leads will not interfere with the operation of the motor.

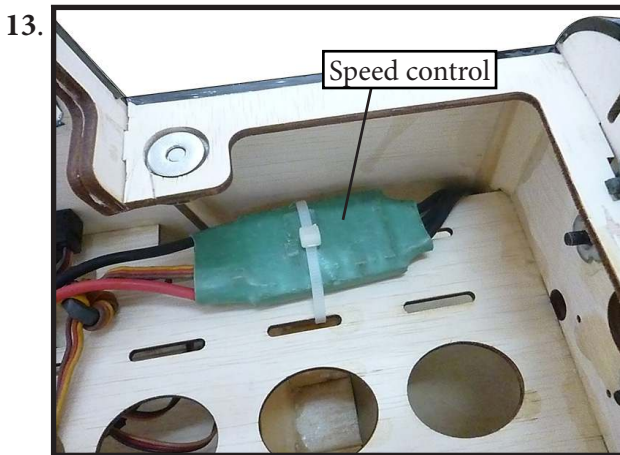

INSTALLING THE SPINNER

- Install the spinner backplate, propeller and spinner cone.



 The propeller should not touch any part of the spinner cone. If it does, use a sharp modeling knife and carefully trim away the spinner cone where the propeller comes in contact with it.



INSTALLING THE HORIZONTAL STABILIZER

- Using a ruler and a pen, locate the centerline of the horizontal stabilizer, at the trailing edge, and place a mark. Use a triangle and extend this mark, from back to front, across the top of the stabilizer. Also extend this mark down the back of the trailing edge of the stabilizer.

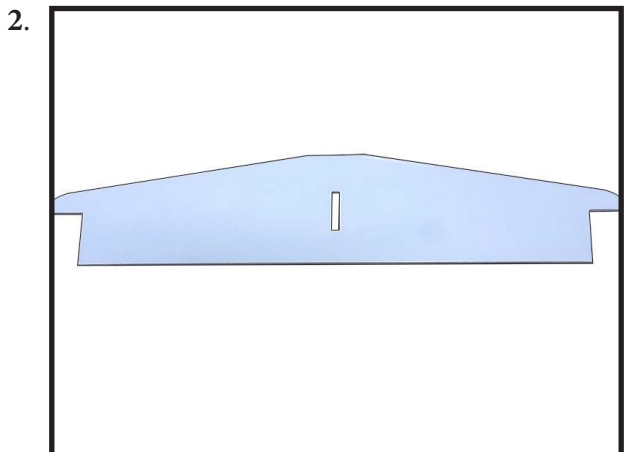
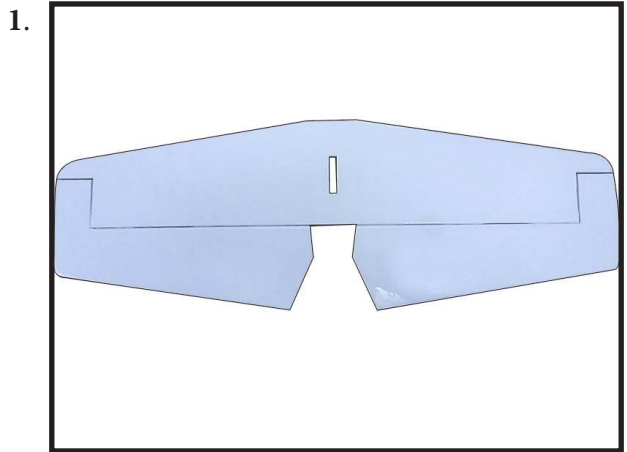

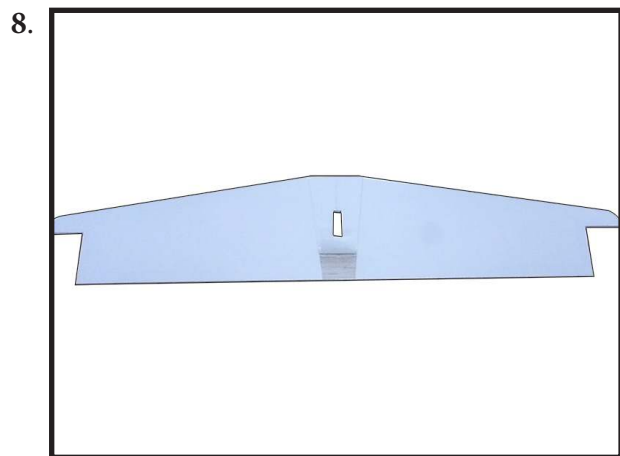
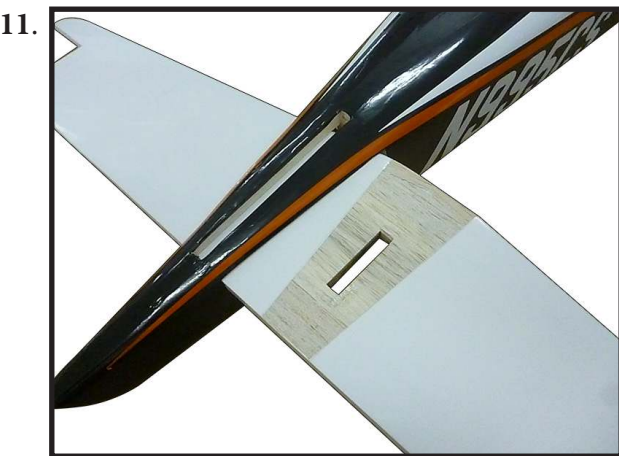
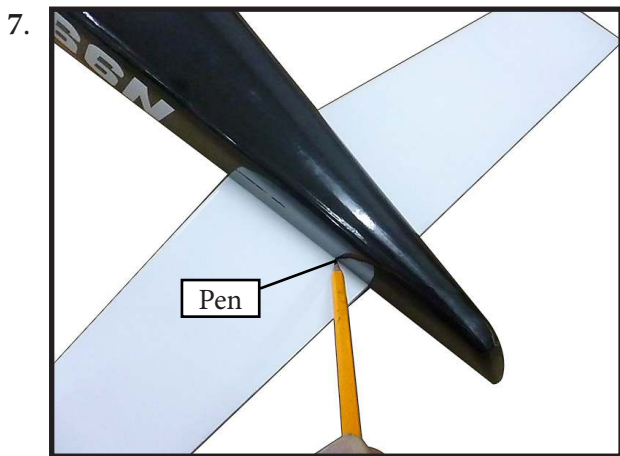
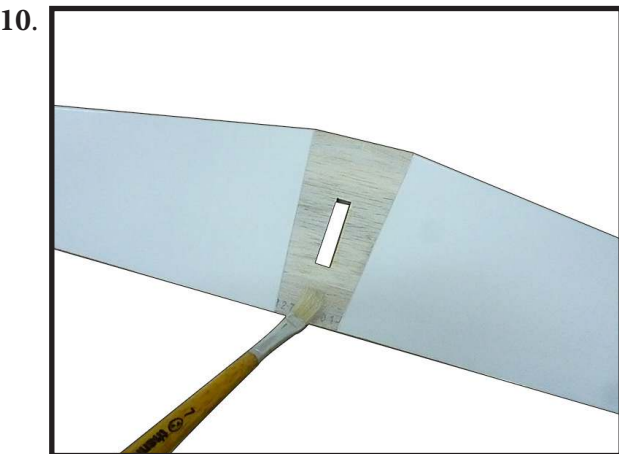
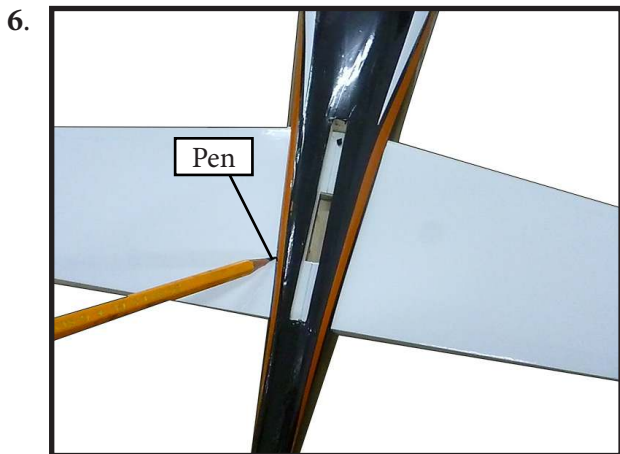
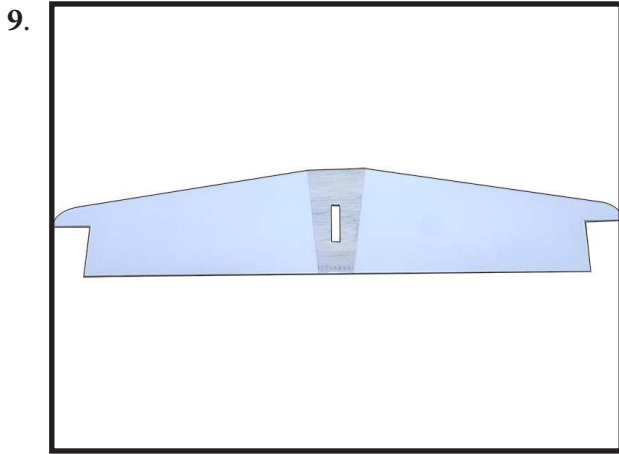
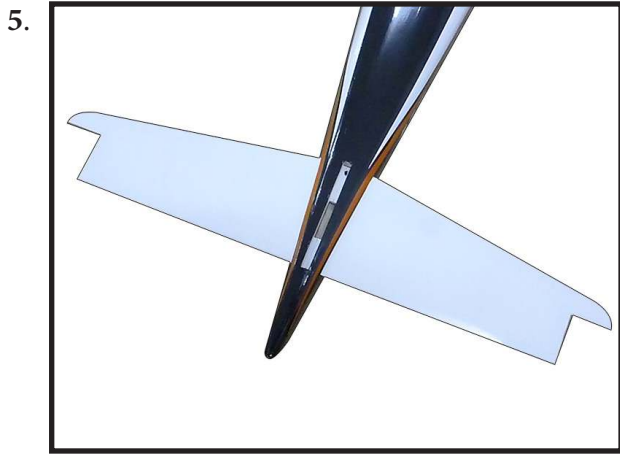

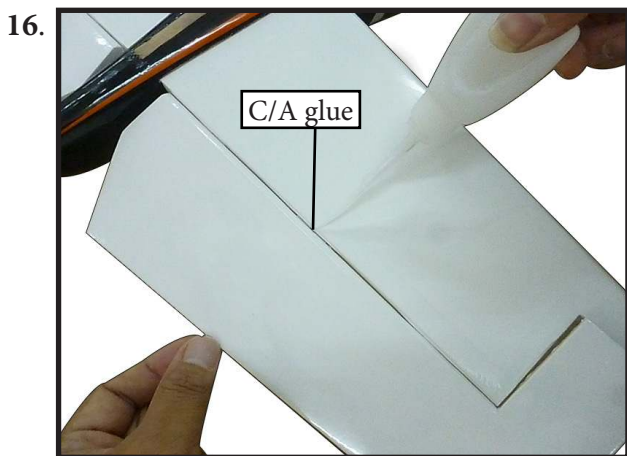
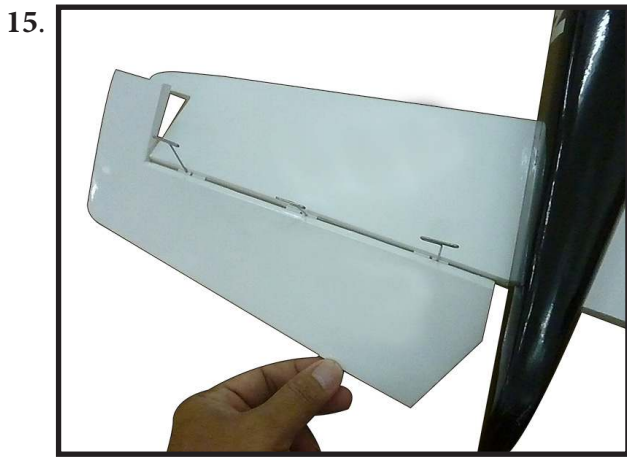
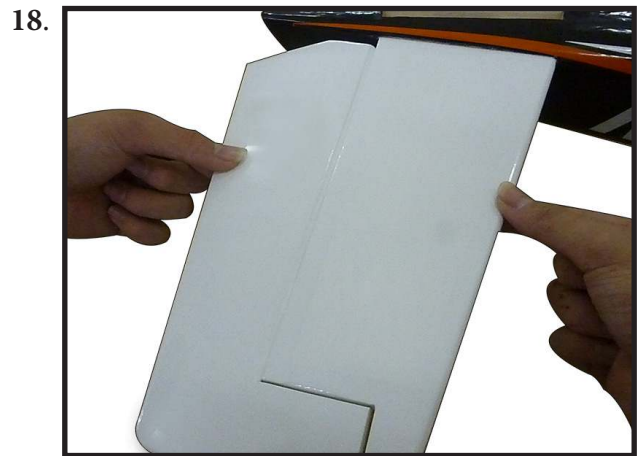
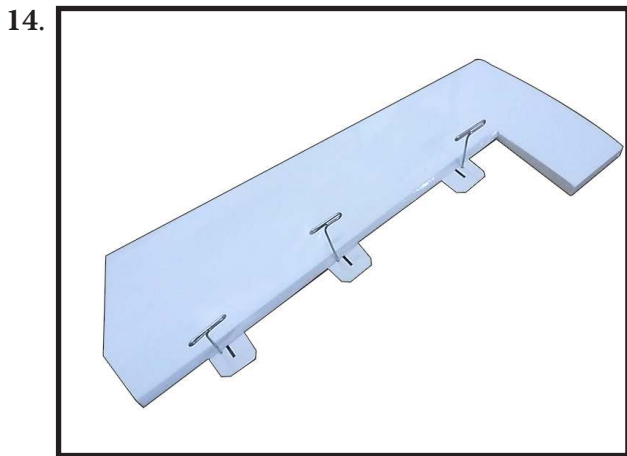
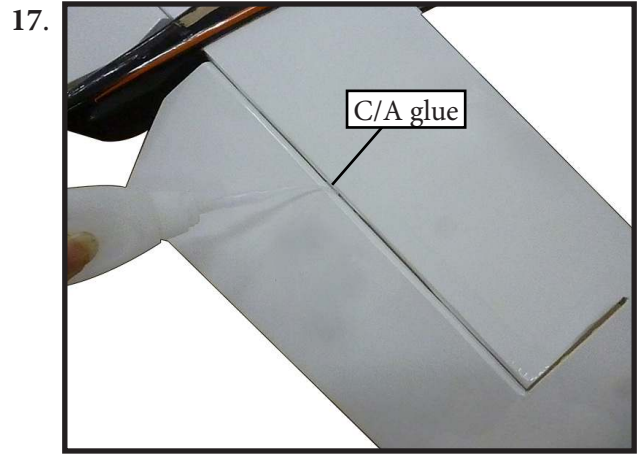
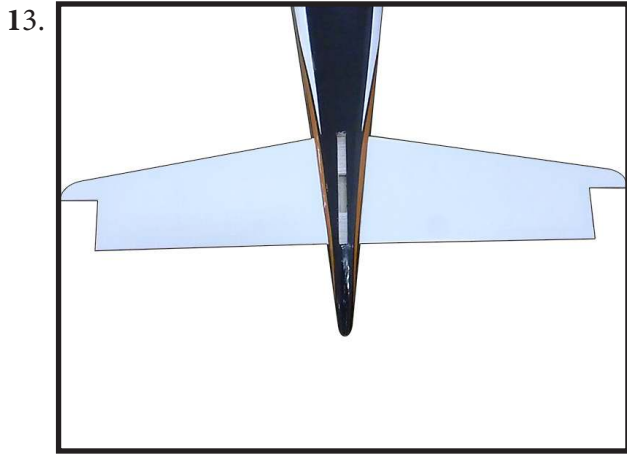

HINGING THE RUDDER

- Glue the top two rudder hinges in place using the same techniques used to hinge the ailerons.
- The lower hinge will be glued when the fi/rudder assembly is attached to the fuselage.

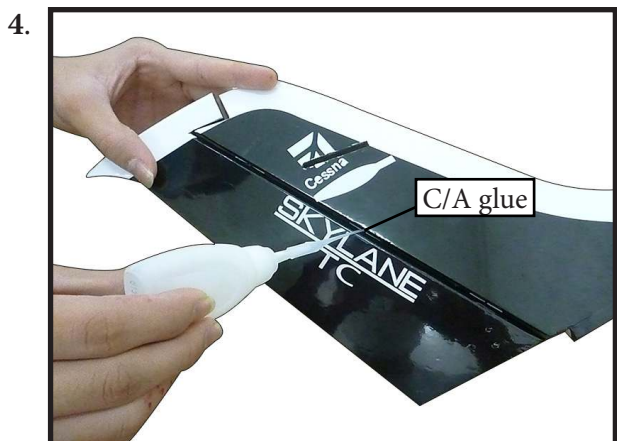
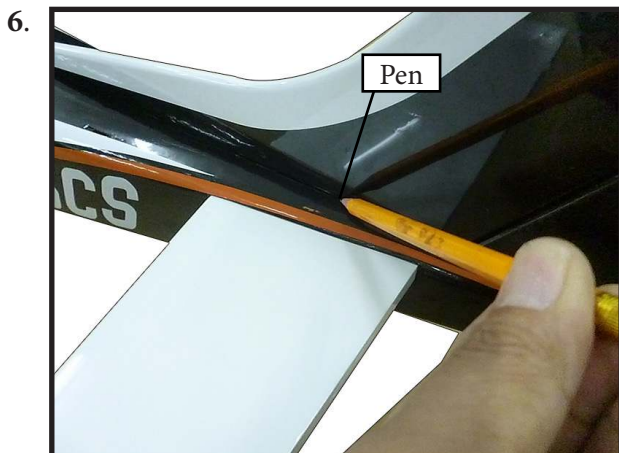
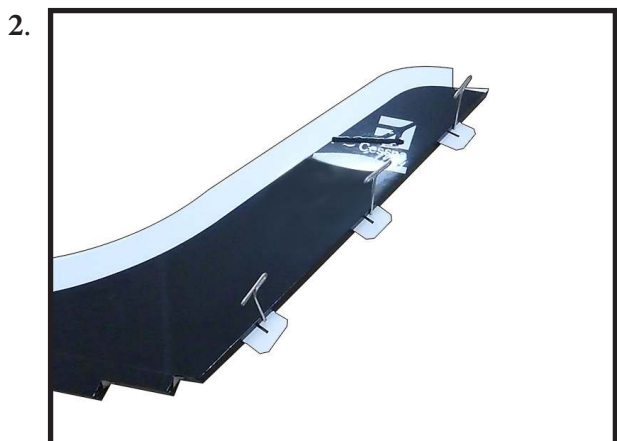
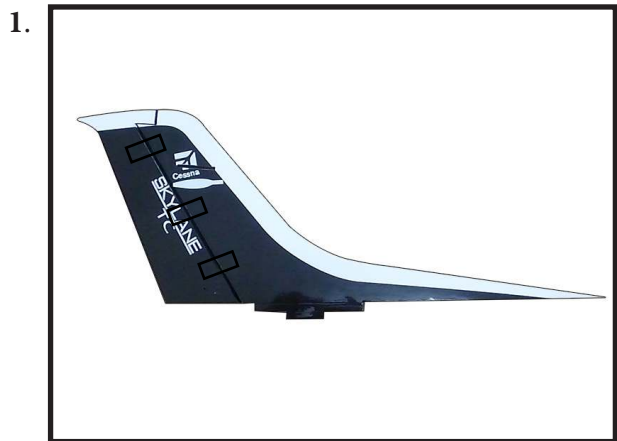

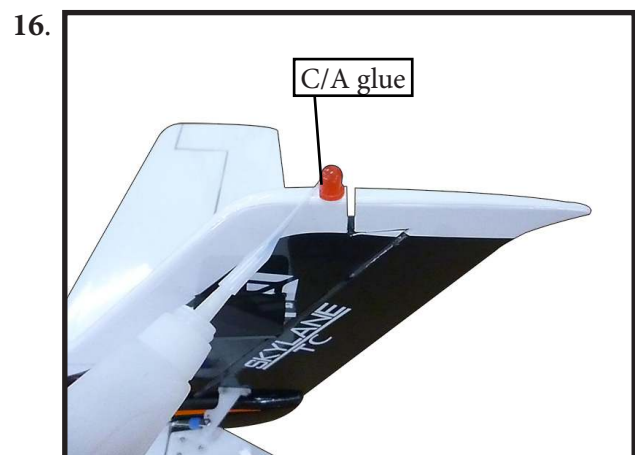
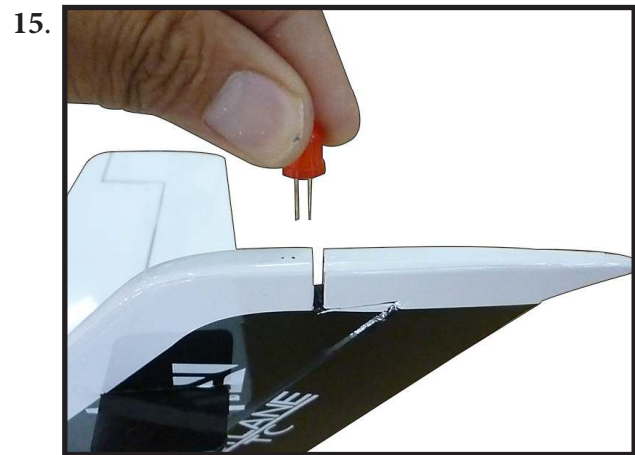
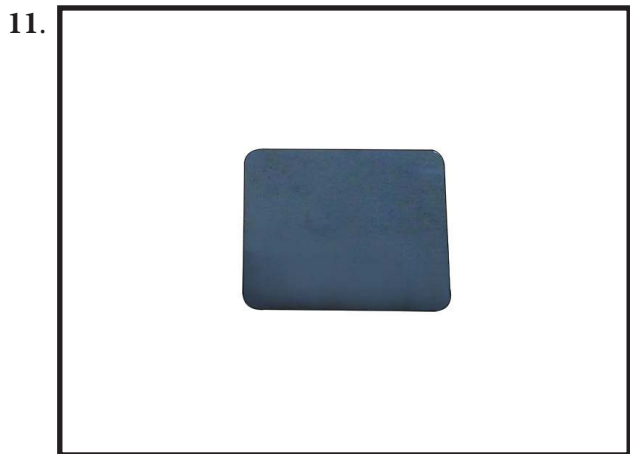
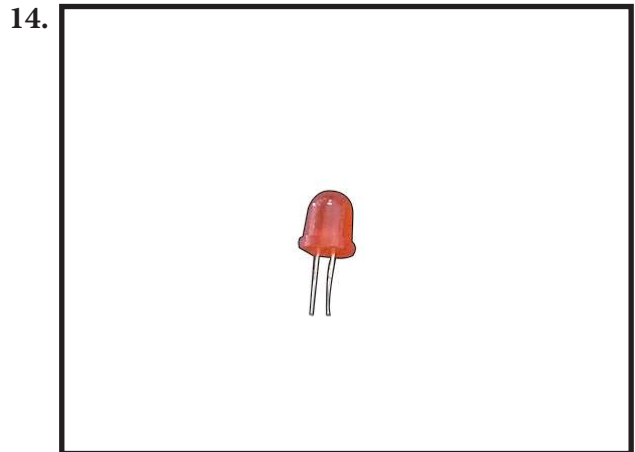
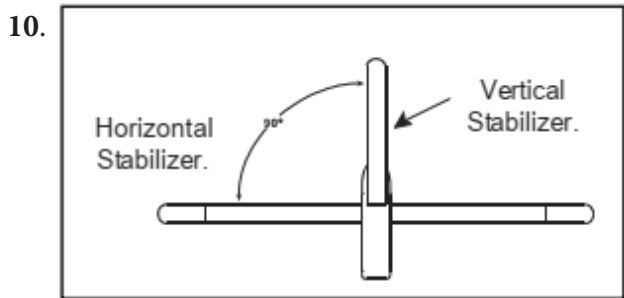
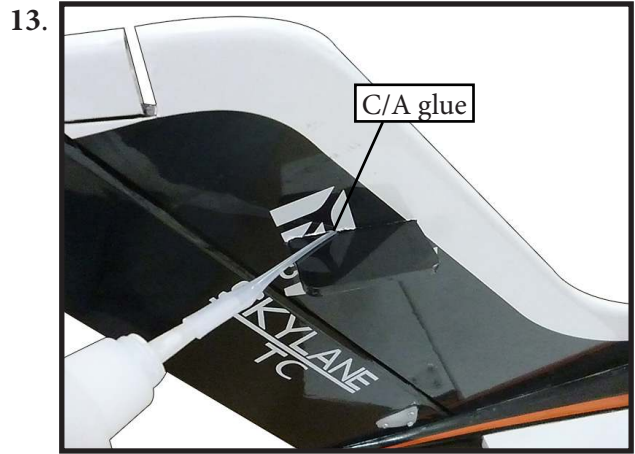
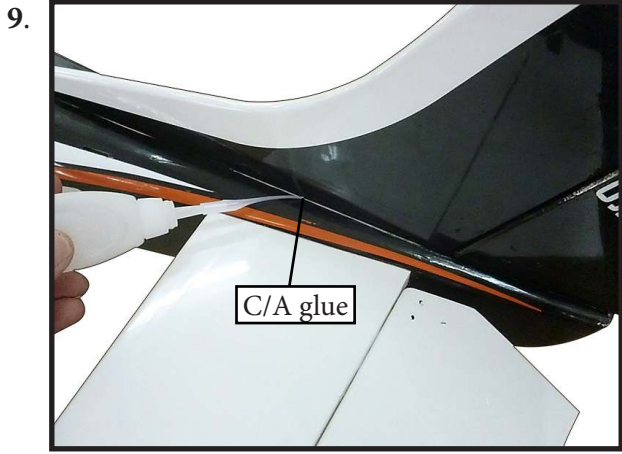

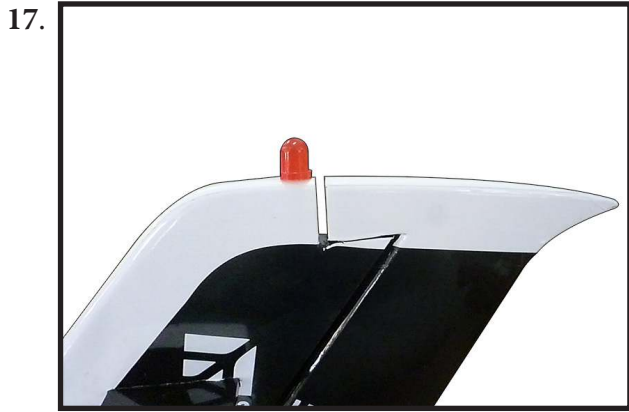

ELEVATOR PUSHROD INSTALLATION

- Install the elevator control horn using the same method as with the aileron control horns.
- Position the elevator control horn on the both side of elevator.

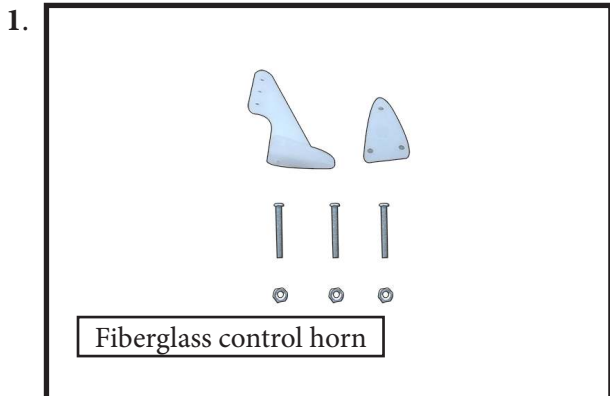

- Locate items necessary to install rudder pushrod.

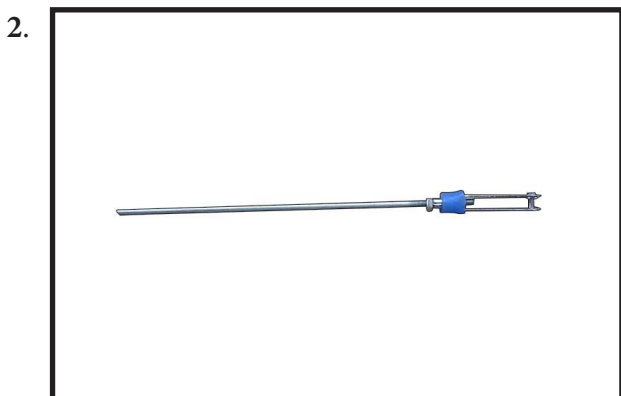

- Install the elevator control horn using the same method as with the aileron control horns.

- Position the elevator control horn on the both side of elevator.



- Thread one clevis and M2 lock nut on to each elevator control rod. Thread the horns on until they are flush with the ends of the control rods.

- Elevator and rudder pushrods assembly as pictures below.



6.



RUDDER PUSHROD INSTALLATION

- Locate items necessary to install rudder pushrod.

1.

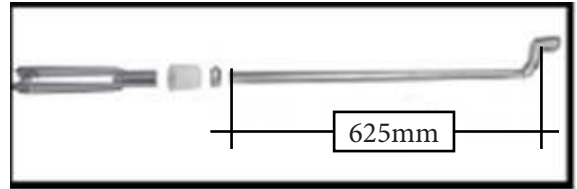

7.



2.



8.



3.



9.



4.



INSTALL THE WINDOW

Parts requirement. See pictures below.

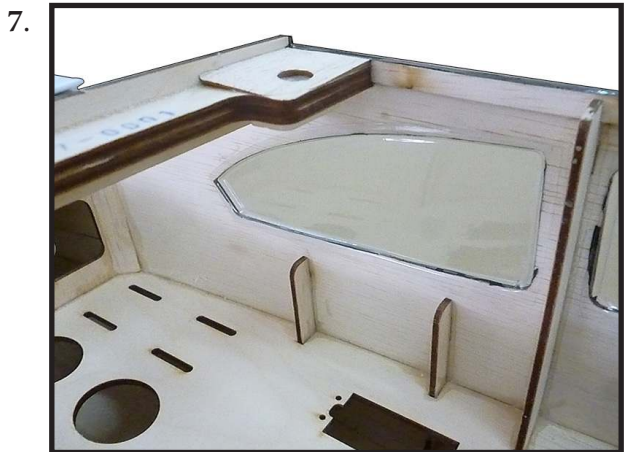
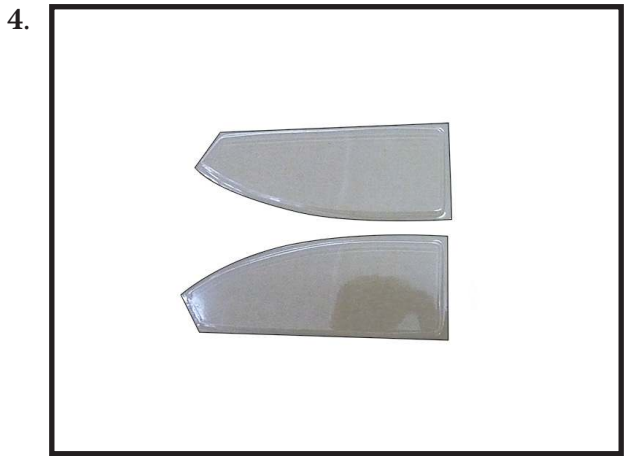
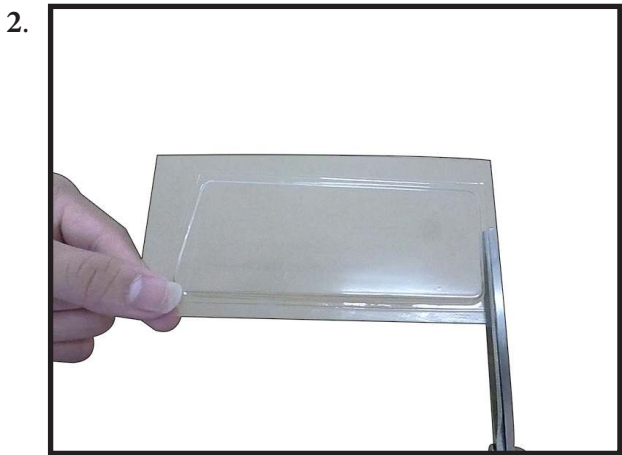

8.

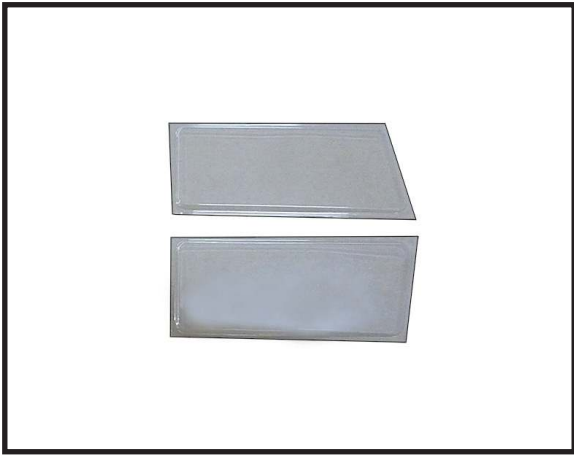

9.

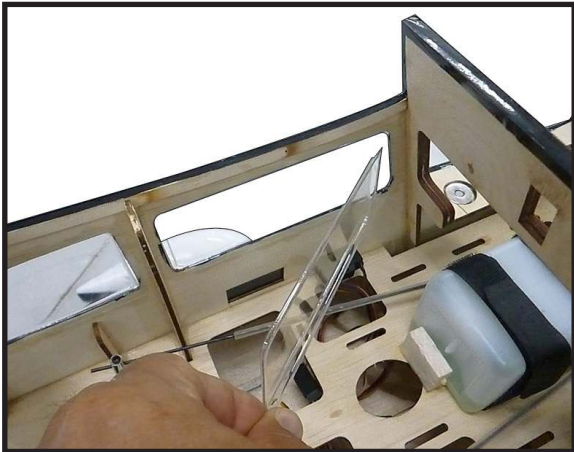

10.

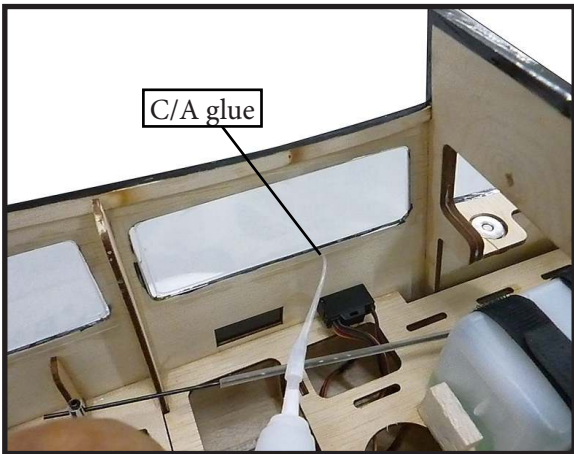

11.

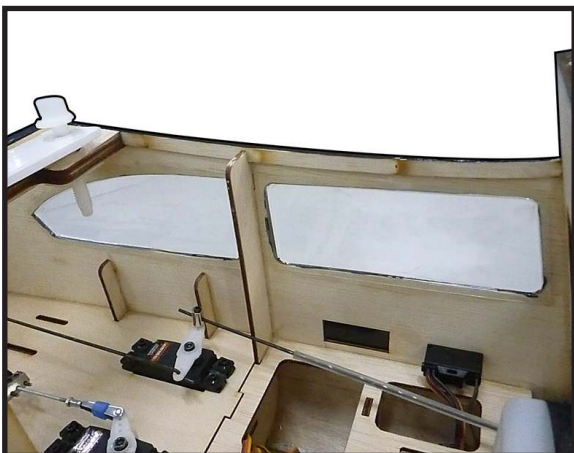

INSTALLATION CANOPY

- Locate items necessary to install canopy.

1.



2.



3.

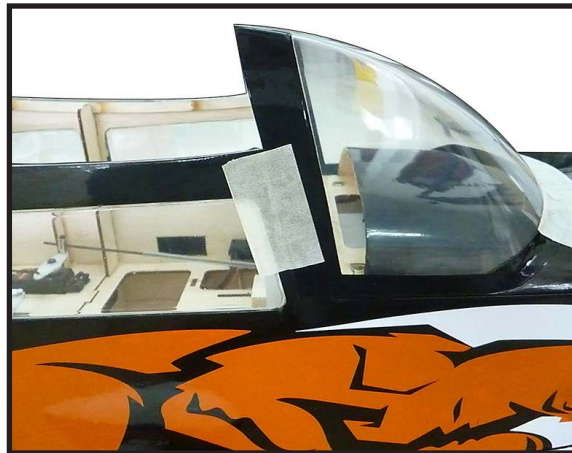

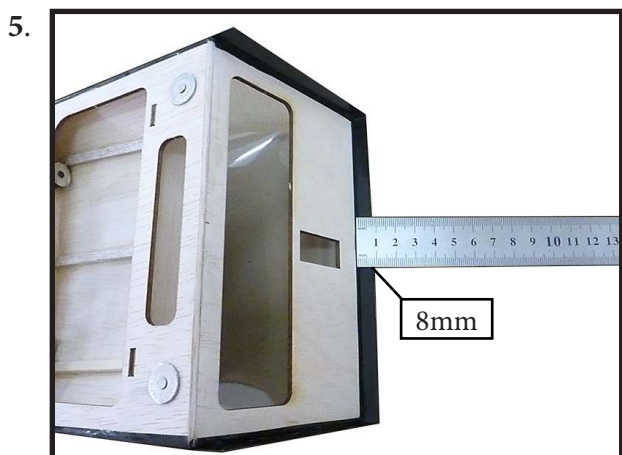

INSTALLING BATTERY - RECEIVER

- Plug the servo leads and the switch lead into the receiver. Plug the battery pack lead into the switch also.

- Wrap the receiver and battery pack in the protective foam rubber to protect them from vibration.

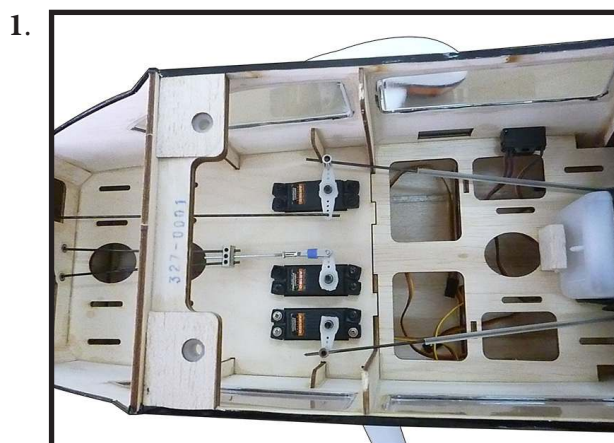

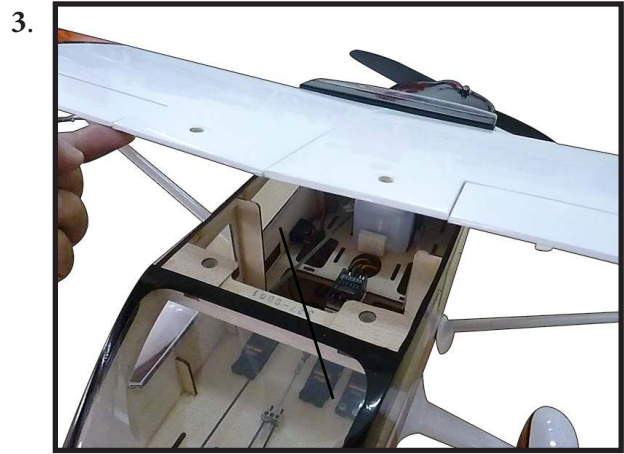
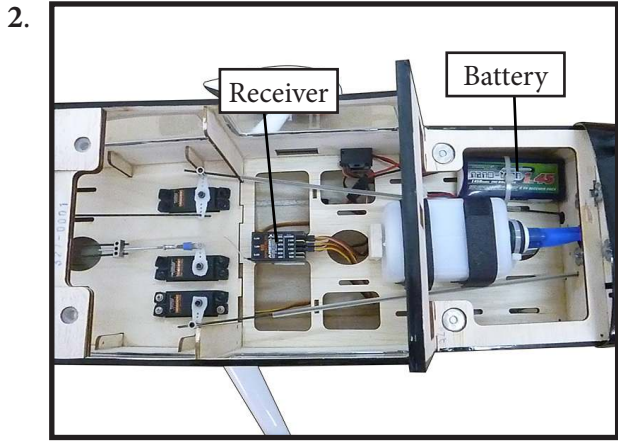

ATTACHMENT WING- FUSELAGE

- Locate items necessary to intall tail wheel.

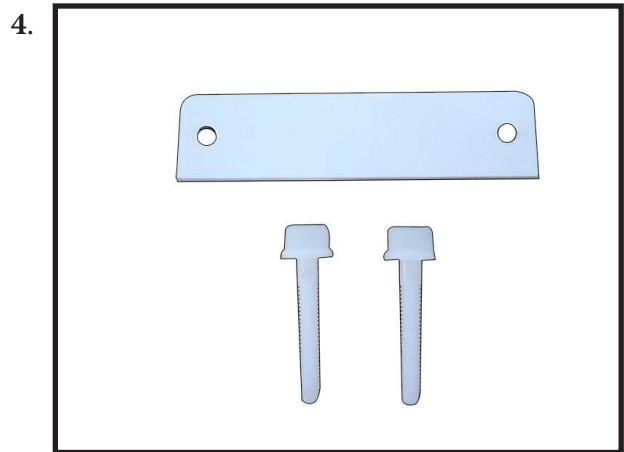
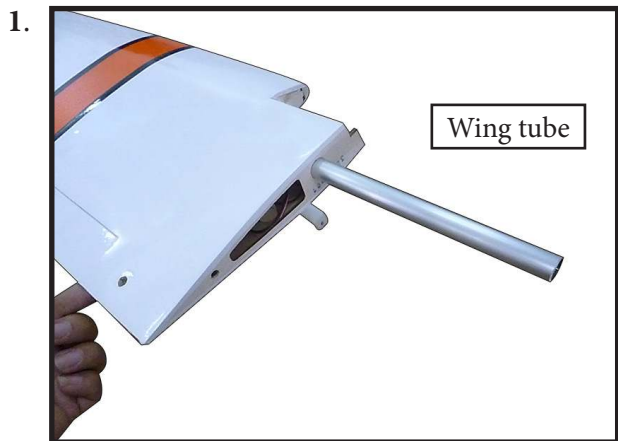

- Insert two wing panels as pictures below.

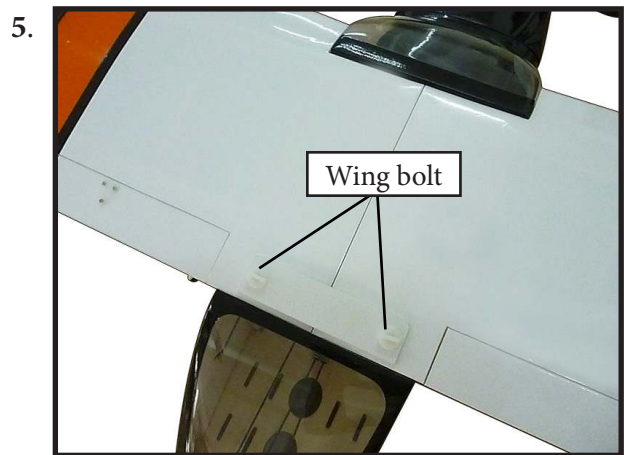
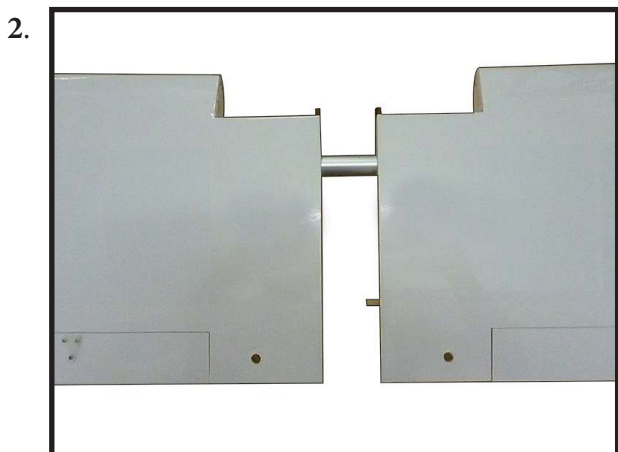

INSTALLATION WING- FUSELAGE STRUTS

- Parts requirement. See pictures below.

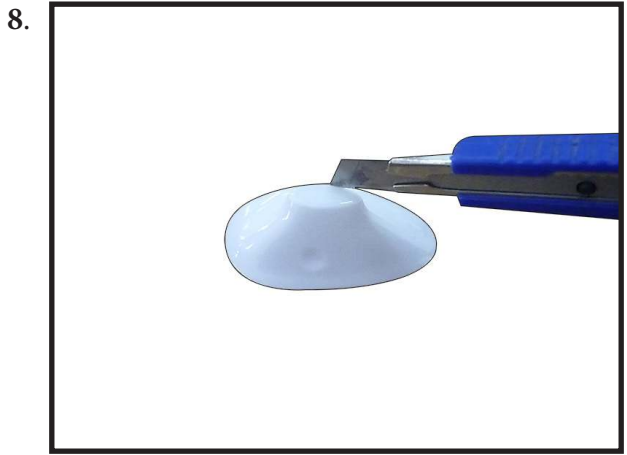
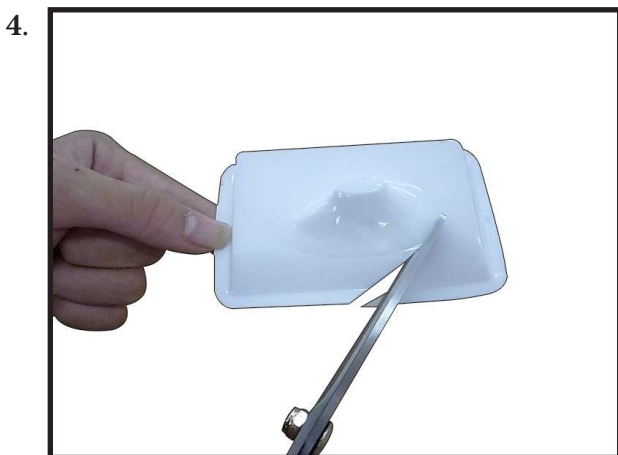
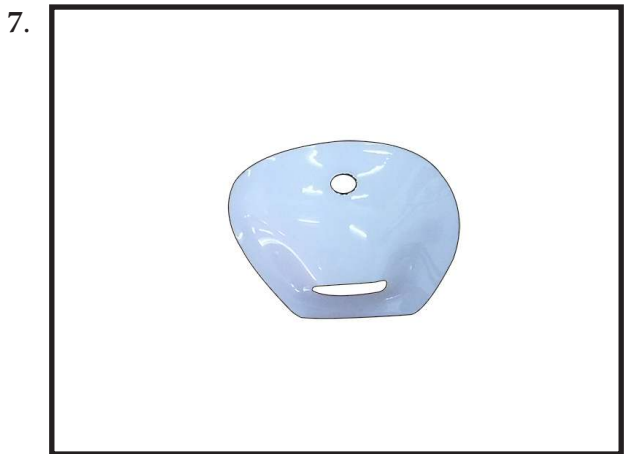
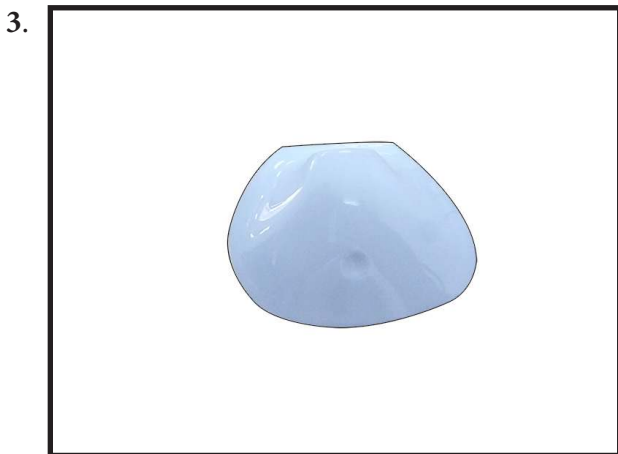
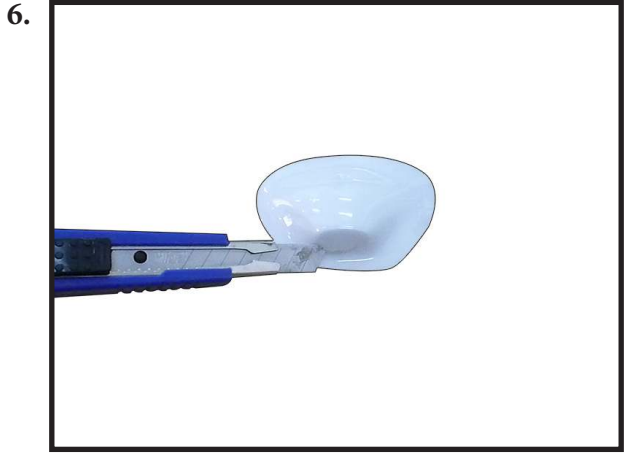
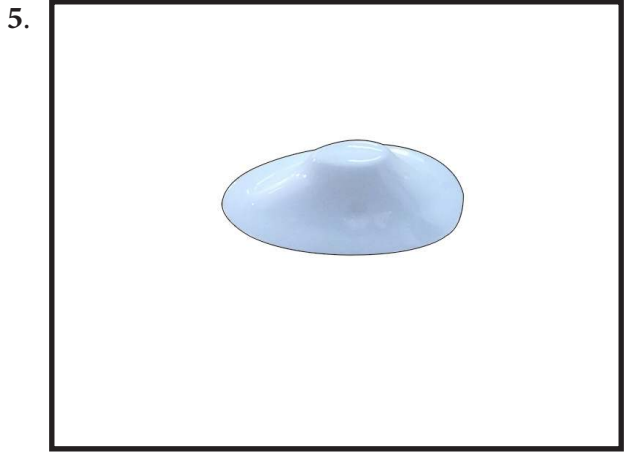

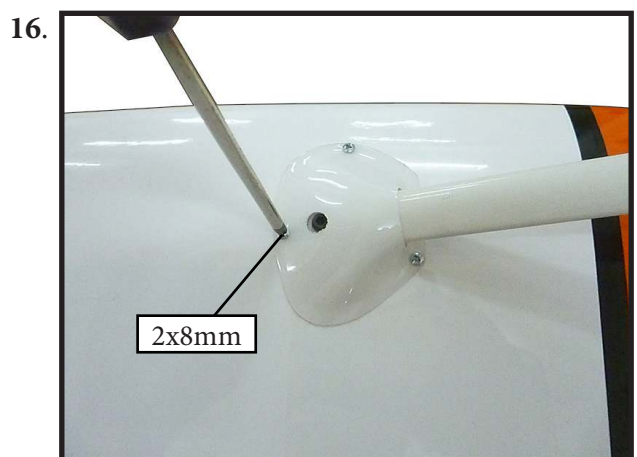
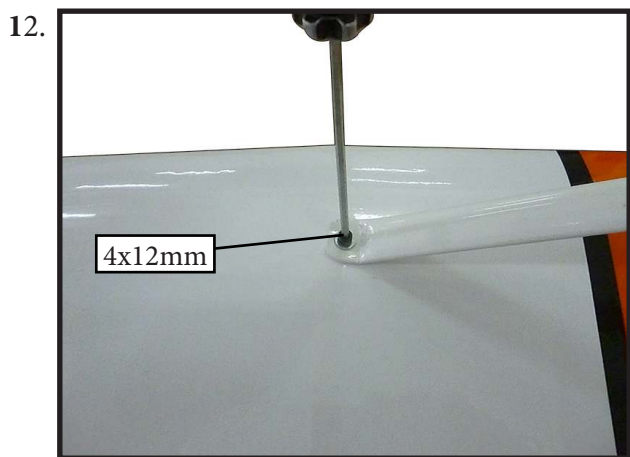
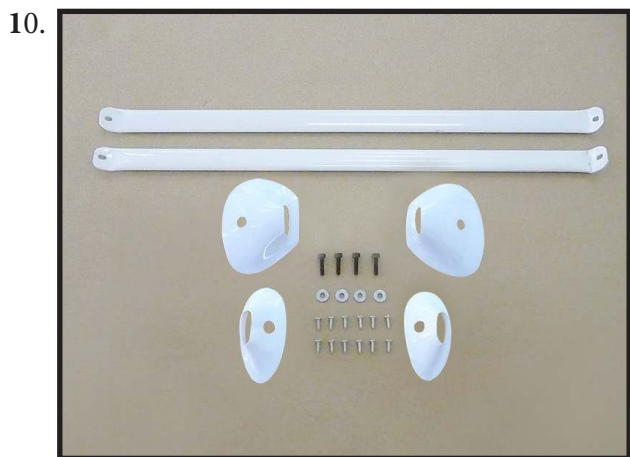
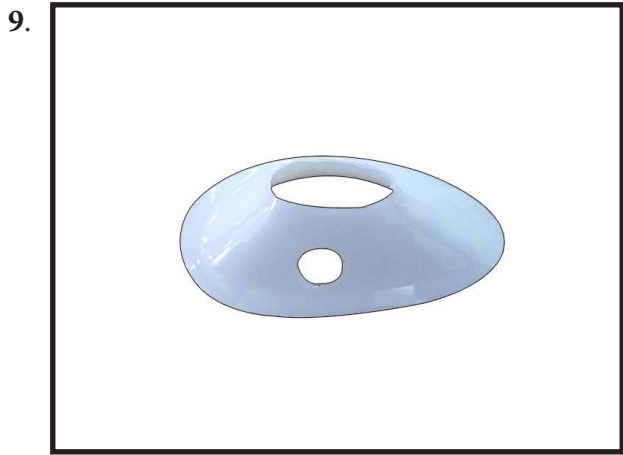

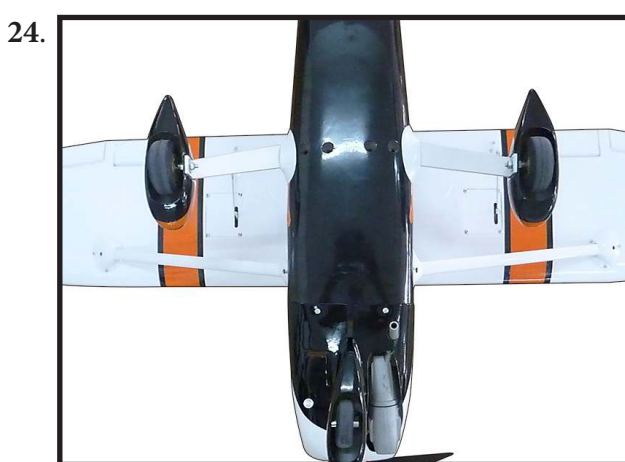
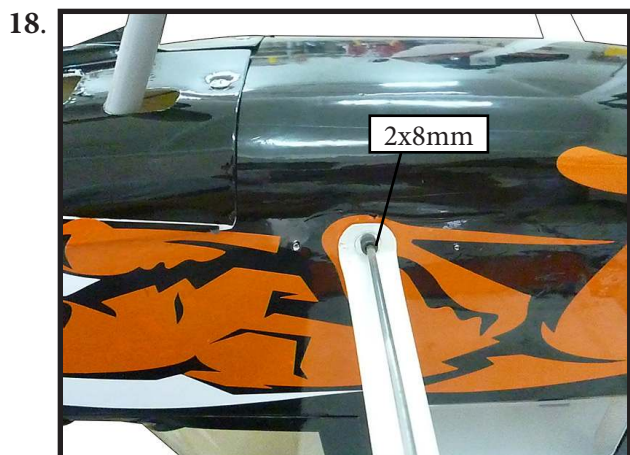
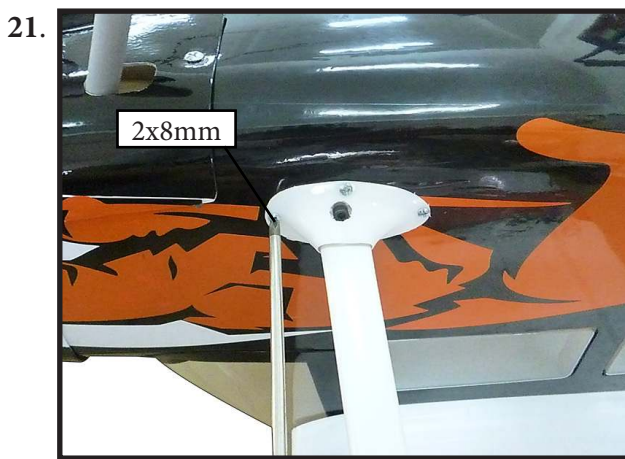

25.

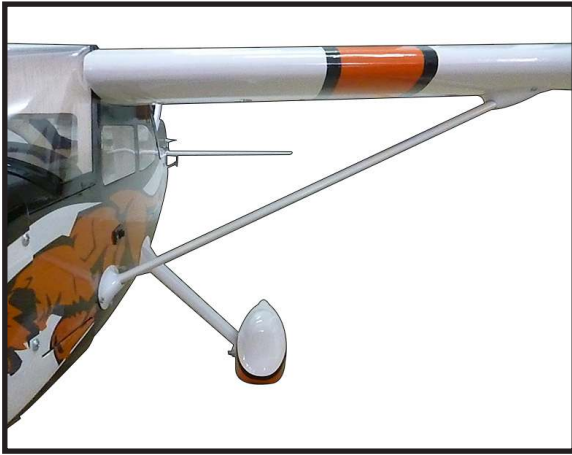

APPLY THE DECALS

- If all the decals are precut and ready to stick. Please be certain the model is clean and free from oily fingerprints and dust. Position decal on the model where desired, using the photos on the box and aid in their location.
- If all the decals are not precut, please use scissors or a sharp hobby knife to cut the decals from the sheet. Please be certain the model is clean and free from oily fingerprints and dust. Position decal on the model where desired, using the photos on the box and aid in their location.

BALANCING

An important part of preparing the aircraft for flight is properly balancing the model.

1) Attach the wing panels to the fuselage. Make sure to connect the leads from the aileron to the appropriate leads from the receiver. Make sure the leads are not exposed outside the fuselage before tightening the wing bolts. Your model should be flight-ready before balancing.

2) The recommended Center of Gravity (CG) location for your model is (80mm) back from the leading edge at the center of the wing.

3) When balancing your model, make sure it is assembled and ready for flight. Support the plane upright at the marks made on the wing with your fingers or a commercially available balancing stand. This is the correct balance point for your model.

*If possible, first attempt to balance the model by changing the position of the receiver battery and receiver. If you are unable to obtain good balance by doing so, then it will be necessary to add weight to the nose or tail to achieve the proper balance point.

With the wing attached to the fuselage, all parts of the model installed (ready to fly), and empty fuel tanks, hold the model at the marked balance point with the stabilizer level.

Lift the model. If the tail drops when you lift, the model is “tail heavy” and you must add weight* to the nose. If the nose drops, it is “nose heavy” and you must add weight* to the tail to balance.

1.

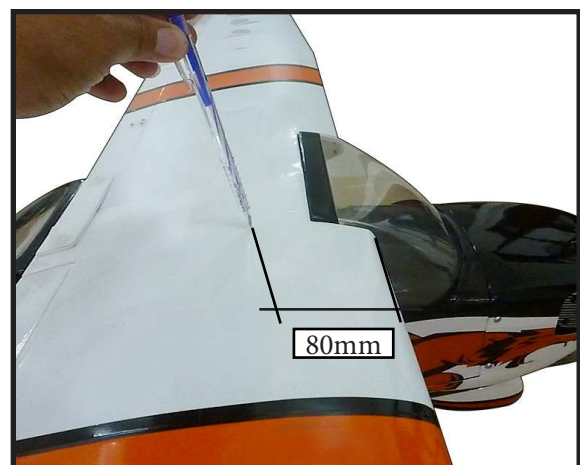

CONTROL THROWS

Ailerons:	Rudder:
High Rate :	High Rate :
Up : 20 mm	Right : 30 mm
Down : 20 mm	Left : 30 mm
Low Rate :	Low Rate :
Up : 15 mm	Right : 25 mm
Down : 15 mm	Left : 25 mm
Elevator:	Flap:
High Rate :	Mid : 30mm
Up : 20 mm	
Down : 20 mm	
Low Rate :	
Up : 15 mm	
Down : 15 mm	

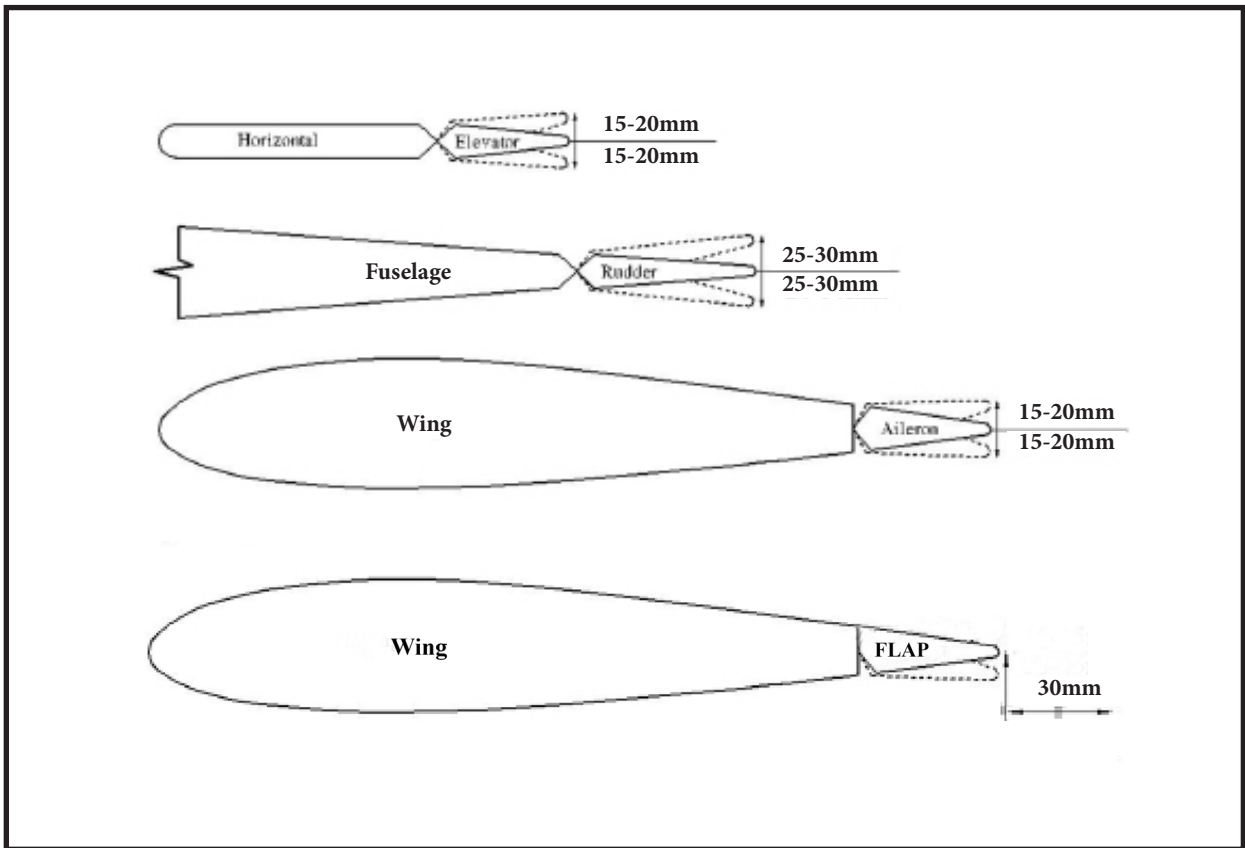

FLIGHT PREPARATION

Check the operation and direction of the elevator, rudder, ailerons and throttle.

A) Plug in your radio system per the manufacturer's instructions and turn everything on.

B) Check the elevator first. Pull back on the elevator stick. The elevator halves should move up. If they do not, flip the servo reversing switch on your transmitter to change the direction.

C) Check the rudder. Looking from behind the airplane, move the rudder stick to the right. The rudder should move to the right. If it does not, flip the servo reversing switch on your transmitter to change the direction.

D) Check the throttle. Moving the throttle stick forward should open the carburetor barrel. If it does not, flip the servo reversing switch on your transmitter to change the direction.

E) From behind the airplane, look at the aileron on the right wing half. Move the aileron stick to the right. The right aileron should move up and the other aileron should move down. If it does not, flip the servo reversing switch on your transmitter to change the direction.

PREFLIGHT CHECK

1) Completely charge your transmitter and receiver batteries before your first day of flying.

2) Check every bolt and every glue joint in the **Cessna Turbo Skylane 182** to ensure that everything is tight and well bonded.

3) Double check the balance of the airplane. Do this with the fuel tank empty.

4) Check the control surfaces. All should move in the correct direction and not bind in any way.

5) If your radio transmitter is equipped with dual rate switches double check that they are on the low rate setting for your first few flights.

6) Check to ensure the control surfaces are moving the proper amount for both low and high rate settings.

7) Check the receiver antenna. It should be fully extended and not coiled up inside the fuselage.

8) Properly balance the propeller. An out of balance propeller will cause excessive vibration which could lead to engine and/or airframe failure.

*We wish you many safe and enjoyable flights
with your **Cessna Turbo Skylane 182.***

*If you have any queries, or are interested in our products,
please feel free to contact us*

Factory : 12/101A - Hamlet 4 - Le Van Khuong Street - Dong Thanh Ward -
Hoc Mon District - Ho Chi Minh City - Viet Nam.

Office : 62/8 Ngo Tat To Street - Ward 19 - Binh Thanh District - Ho Chi Minh
City - Viet Nam

Phone : 848 - 86622289 or 848- 36018777

Website : www.SeagullModels.com

Email : Sales@seagullmodels.com

Facebook : www.facebook.com/SeaGullModels.