

FUNNYSTAR



#		Benötigtes Zubehör	Recommended Equipment	Équipement recommandé
1-01913	1	Antriebssatz 6Blade Funnystar / Jets	Power set 6Blade Funnystar / Jets	Motorisation 6Blade Funnystar / Jets
1-01724	2	Servo MS8510 MG Digital	Servo MS8510 MG Digital	Servo MS8510 MG Digital
1-01190	1	Empfänger RX-5 slim M-Link 2,4 GHZ	Receiver RX-5 slim M-Link 2,4 GHZ	Récepteur RX-5 slim M-Link 2,4 GHZ
852727	1	Zacki ELAPOR 20g	Zacki ELAPOR 20g	Zacki ELAPOR 20g
1-01032	1	Zackivator - Aktivator für CA Kleber	Zackivator - Kicker for CA adhesives	Zackivator - Activateur pour colles cyano
1-00016	1	ROXXY EVO LiPo 2 - 450B 30C	ROXXY EVO LiPo 2 - 450B 30C	ROXXY EVO LiPo 2 - 450B 30C

Technische Daten / Specifications / Caractéristiques techniques

Spannweite/ Wingspan / Envergure	850mm
Länge / length / Longueur hors tout	795mm
Fluggewicht / Flight weight / Masse en vol	175g
Steuerkanäle / Channels / Voies de commande	3
Flugzeit / Flight time / Temps de vol	6 min

Benötigtes Werkzeug

- kleiner Kreuzschlitzschraubendreher
- kleiner Schlitzschraubendreher
- Cuttermesser
- Spitzzange

Required tool

- Small cross-tip screwdriver
- Small slotted screwdriver
- Cutter
- Pointed pliers

Outils requis

- Petit tournevis cruciforme
- Petit tournevis plat
- Cutter
- Pince à bec

pcs.	Bezeichnung	Name	Désignation	Material	Dimensions
1	BK Funnystar Bauanleitung	Instruction Manual	Notice de montage kit Funnystar	Paper	DIN A-4
1	Rumpfseitenteil links	Fuselage Left	Partie gauche du fuselage	EPP	
1	Rumpfseitenteil rechts	Fuselage Right	Partie droite du fuselage	EPP	
1	Rumpfmittelteil oben	Fuselage Top	Partie supérieure du fuselage	EPP	
1	Rumpfmittelteil unten	Fuselage Bottom	Partie inférieure du fuselage	EPP	
1	Höhenleitwerk	Elevator	Stabilisateur	EPP	
1	Seitenleitwerk	Rudder	Dérive	EPP	
1	Tragfläche	Wing	Aile	EPP	
1	Kabinenhaubenteile	Canopy parts	Pièces de cabine	EPP	
4	Gabelkopf	Fork head	Chape	Plastik	
4	Druckstift für Gabelkopf	Clevis pin for fork head	Bouton pression pour chape	Messing/ Brass	1 x 5mm
1	Gewindehülse 0,8mm	Threaded coupler 0.8mm	Douille filetée 0,8 mm	Messing/ Brass	M2 x 14mm
2	Rohradapterstück	Tube adapter	Adaptateur tube	Plastik	2 x 5mm
2	Ruderhebel	Rudder horn	Guignol	Plastik	
2	Magnet halter	Magnet holder	Support d'aimant	Plastik	
2	Scheiben Magnet	Magnet	Aimant	Stahl / Steel	
1	Rändelschraube	knurled screw	Vis moletée	Plastik	M4 x 50mm
1	Unterlegscheibe	washer	Rondelle	Plastik	18mm
1	Einpressmutter M4	Press-in nut M4	Ecrou M4	Aluminium	M4 x10
1	Motorspant	Engine frame	Bâti moteur	Holz / Wood	
1	Flächen Aufnahme Oberteil	Wing connection top	Support d'aile supérieur	Holz / Wood	
1	Flächen Aufnahme Unterteil	Wing connection bottom	Support d'aile inférieur	Holz / Wood	
2	Rundstab	Round rod	Tige ronde	CFK	0,8x
2	Kunststoff Rohr	Plastik tube	Tube plastique	Plastik	2.0x

1.

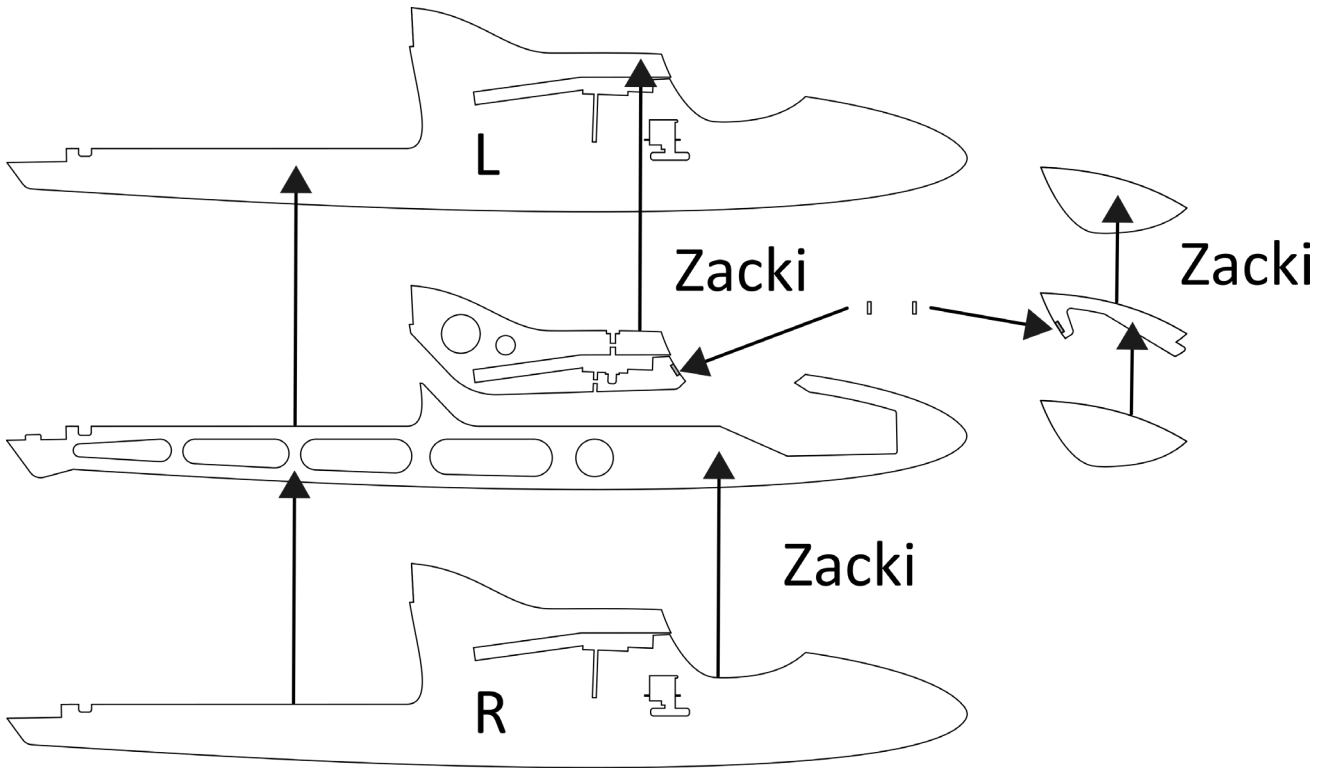

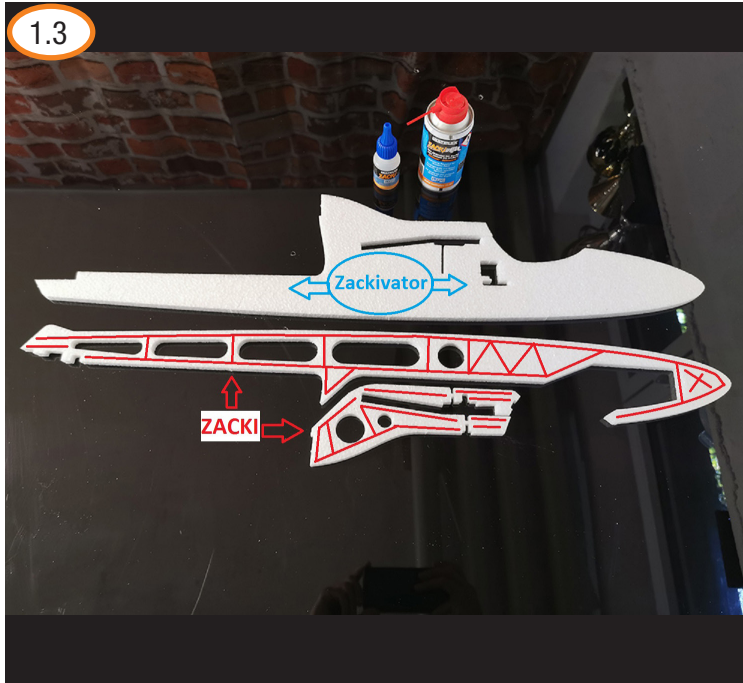

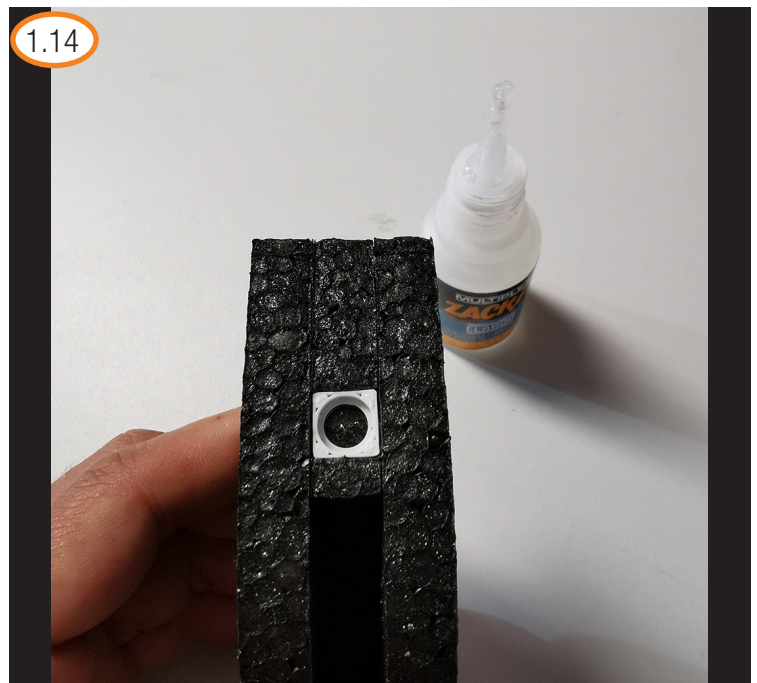
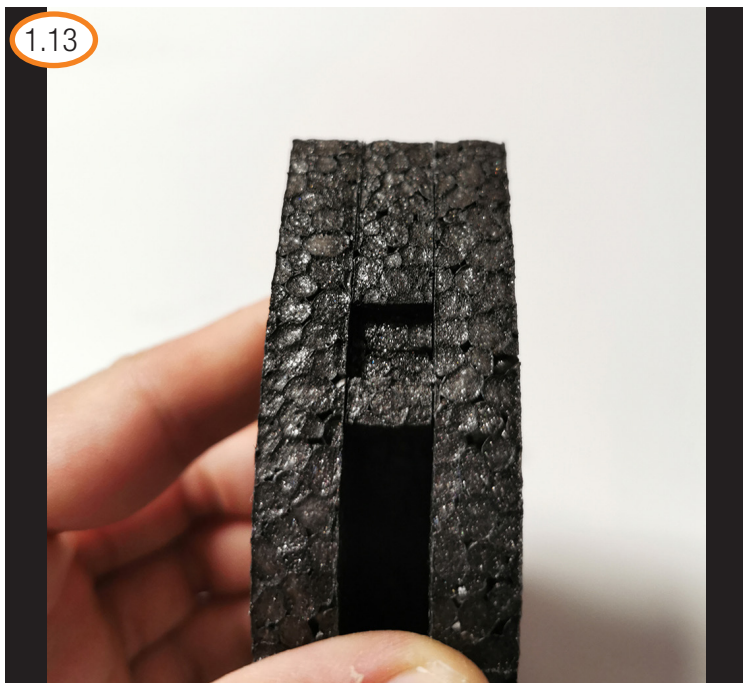
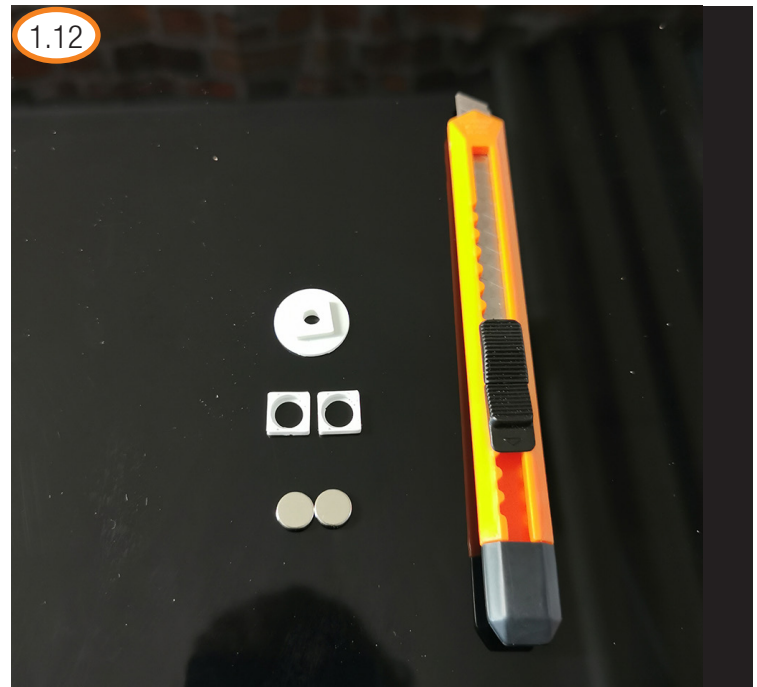

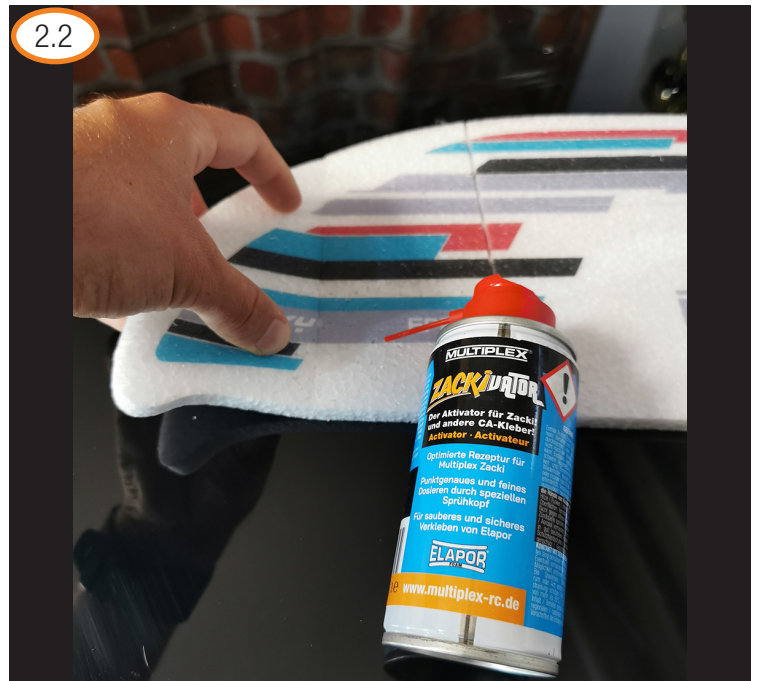
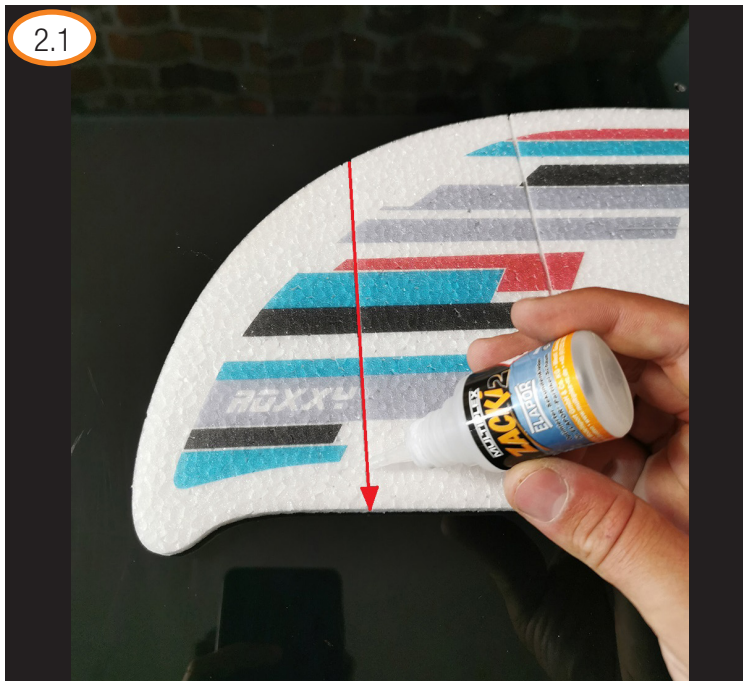
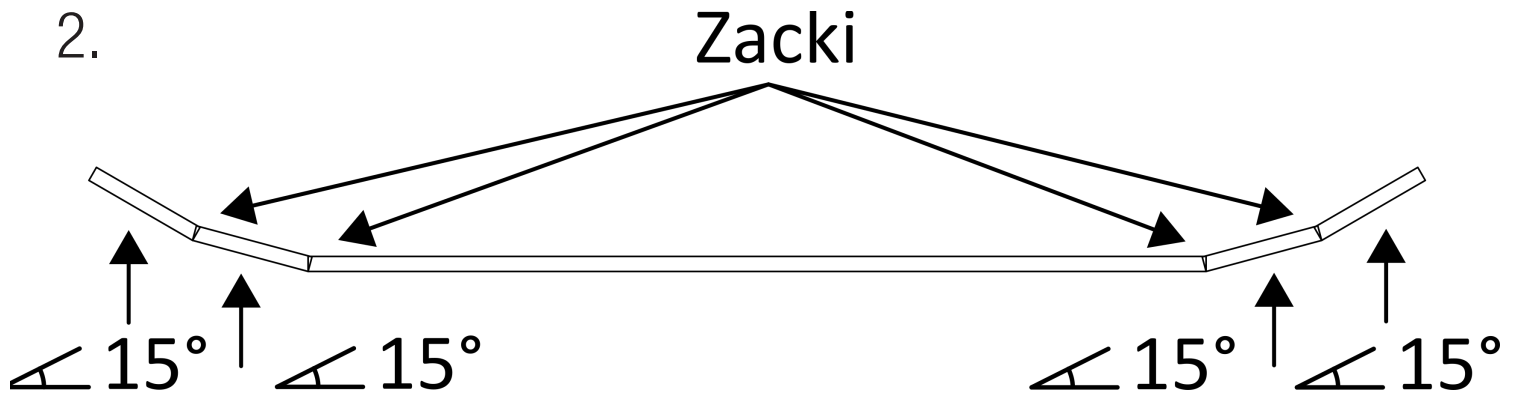
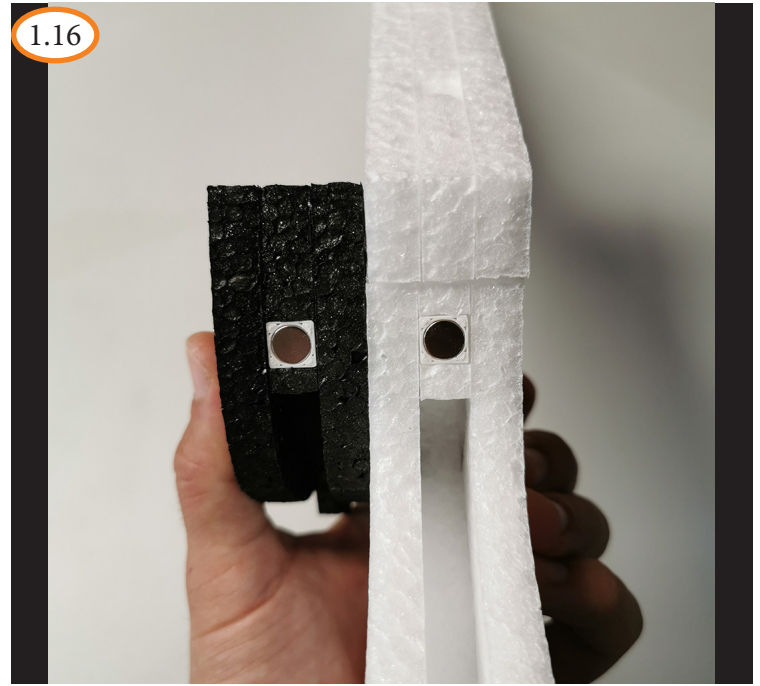

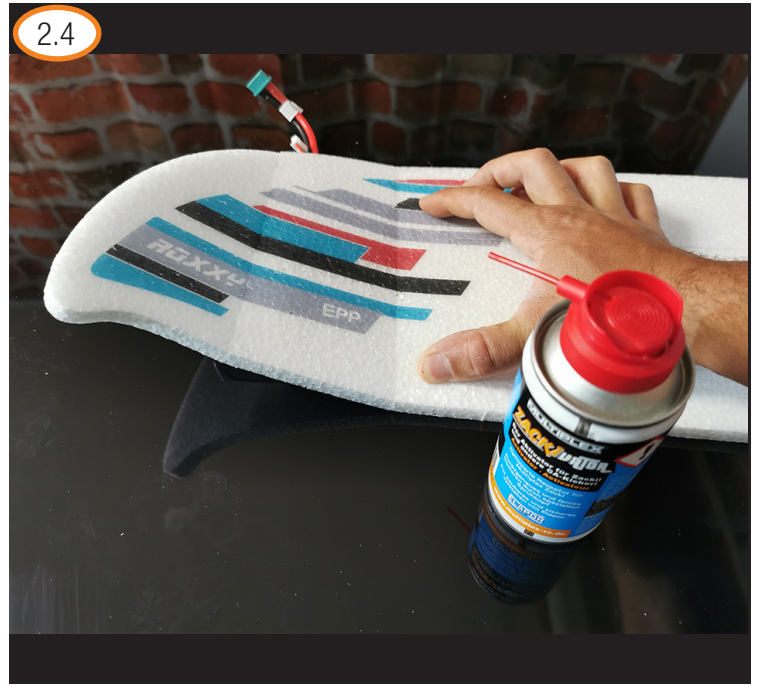

3.

9x500mm

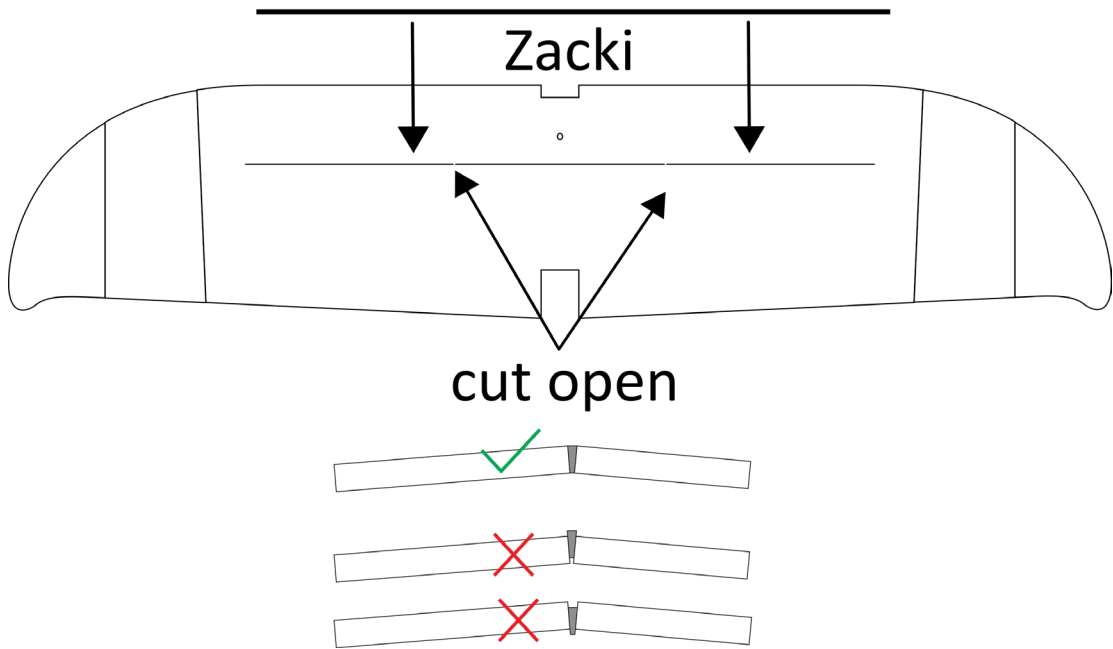

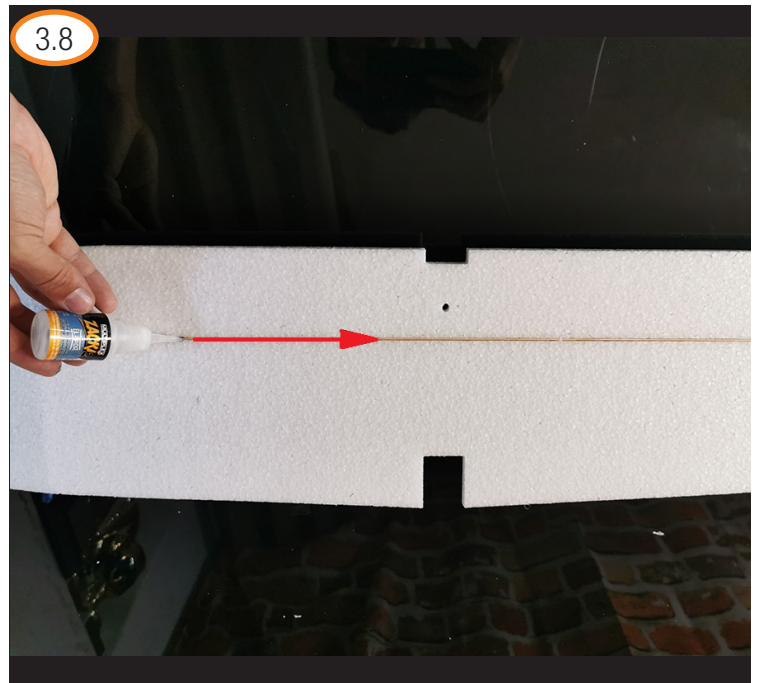
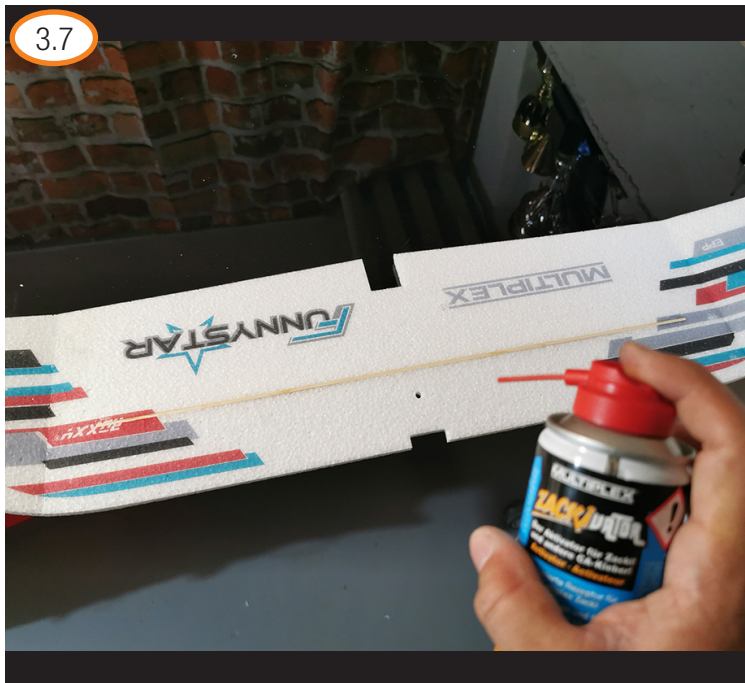
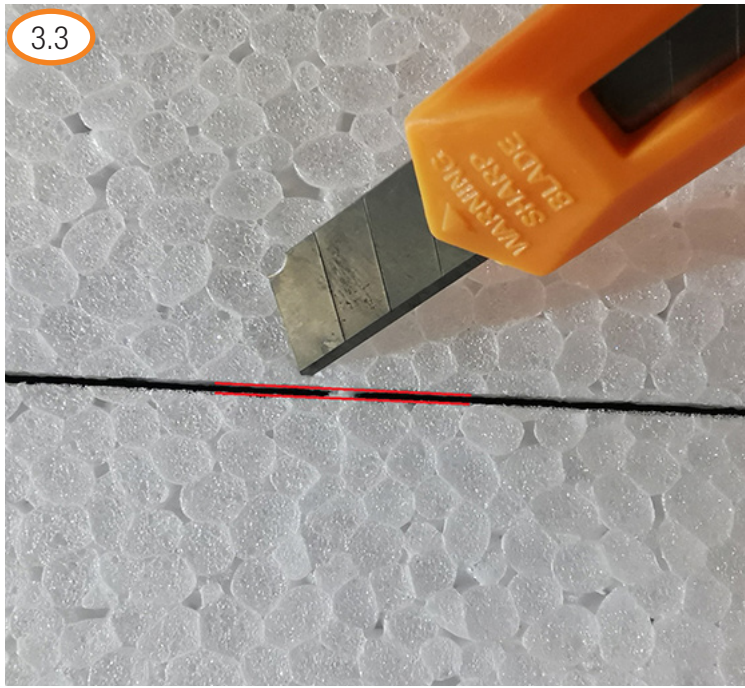



4.

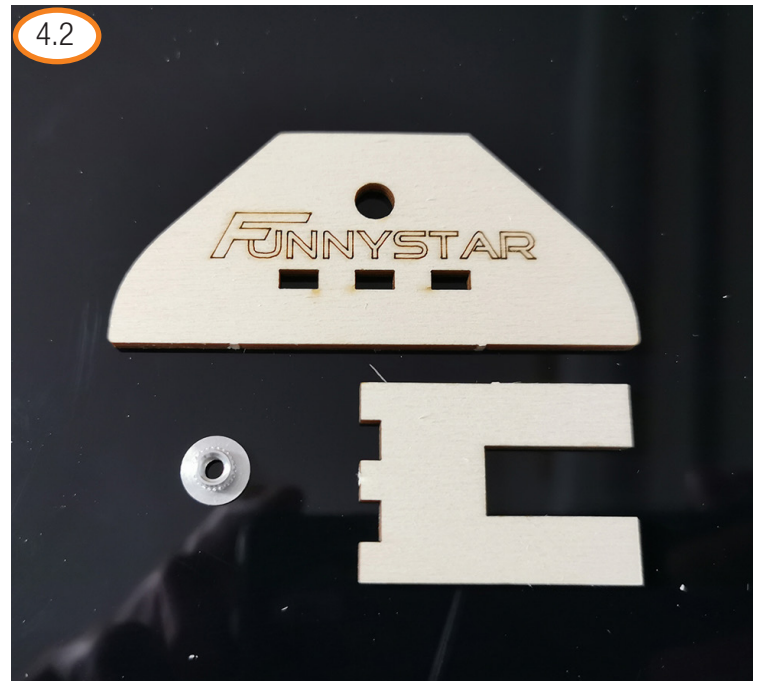
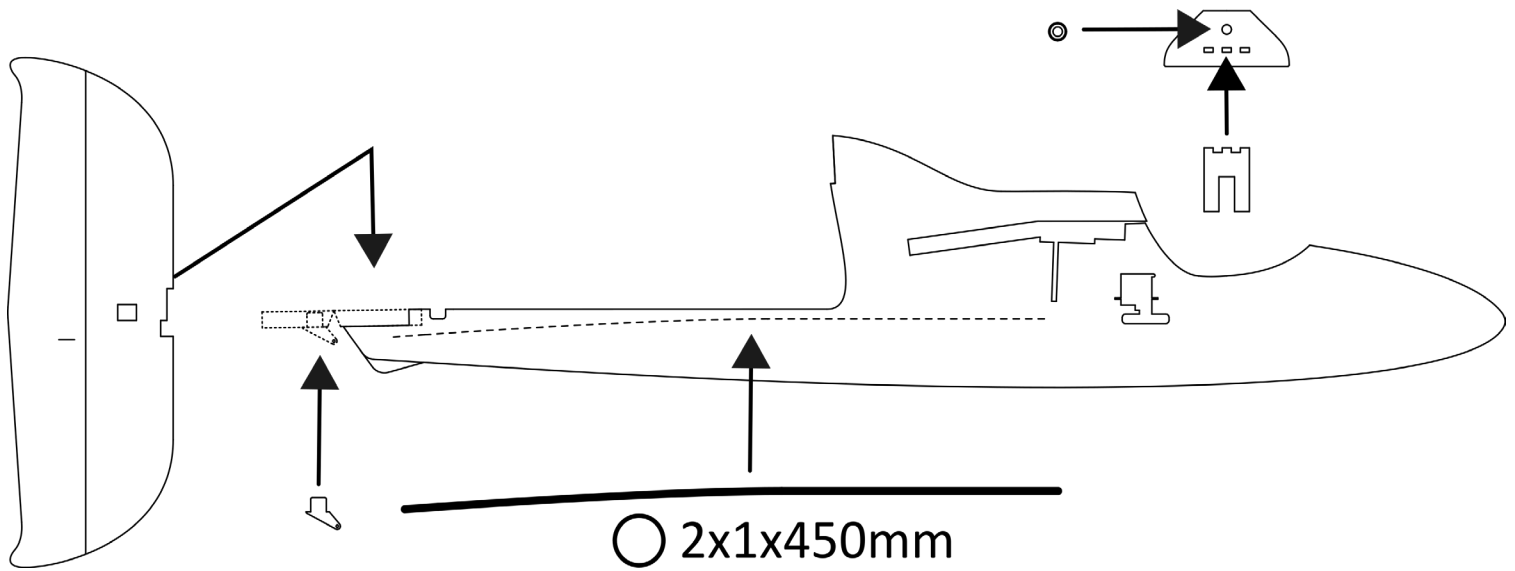

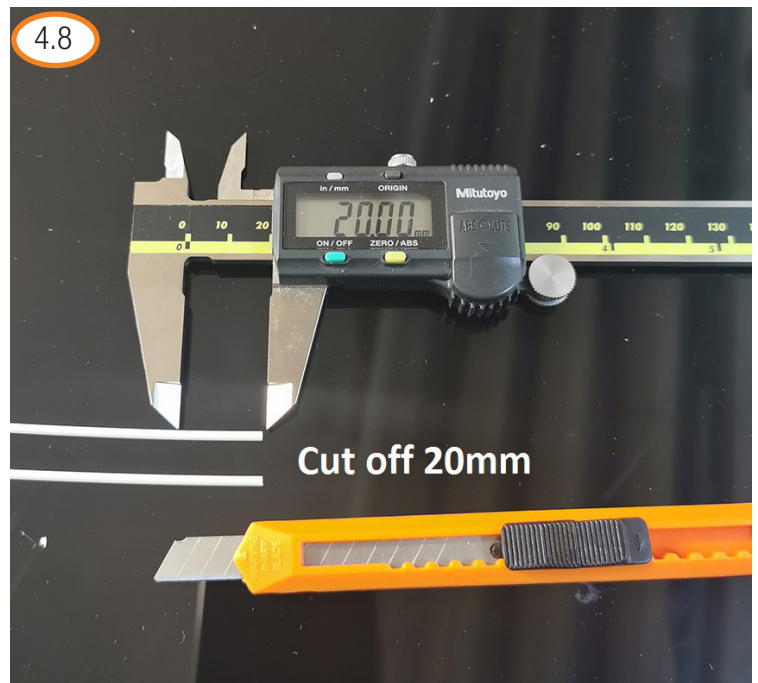
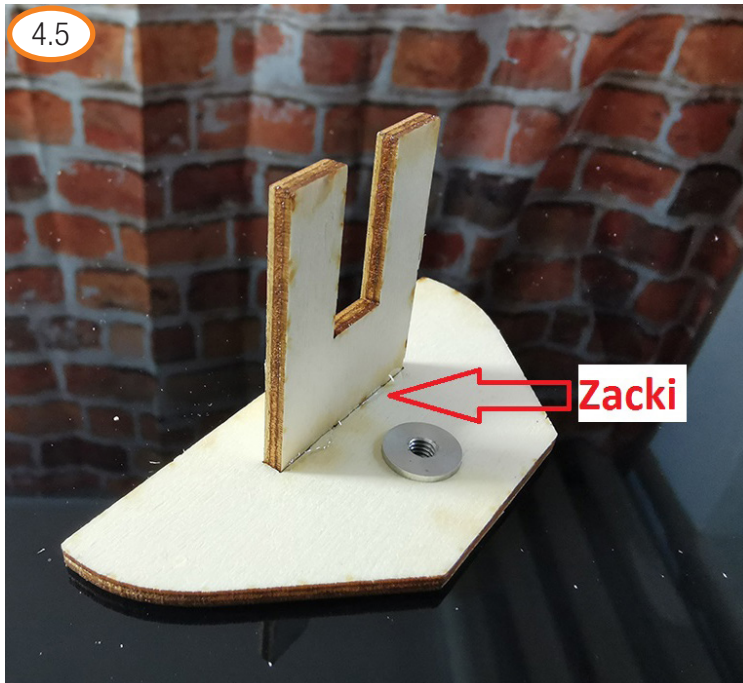
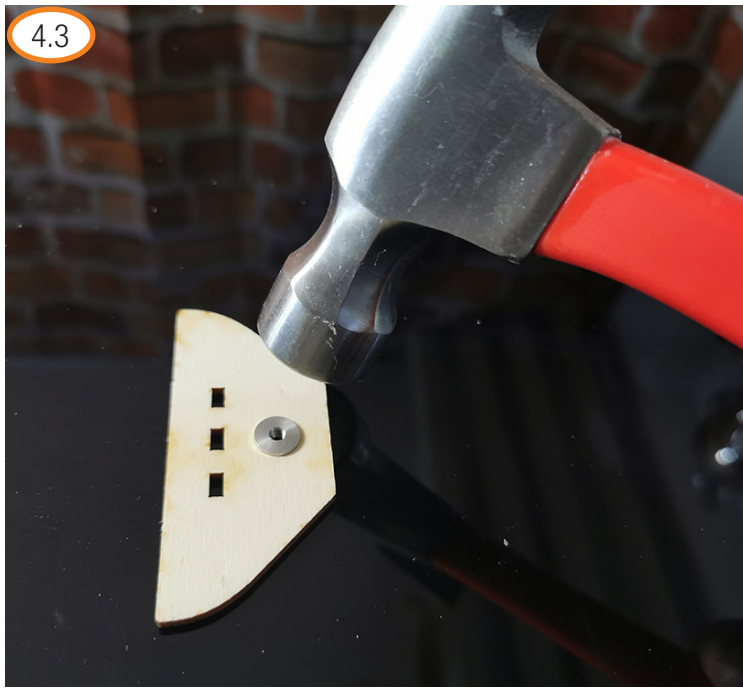

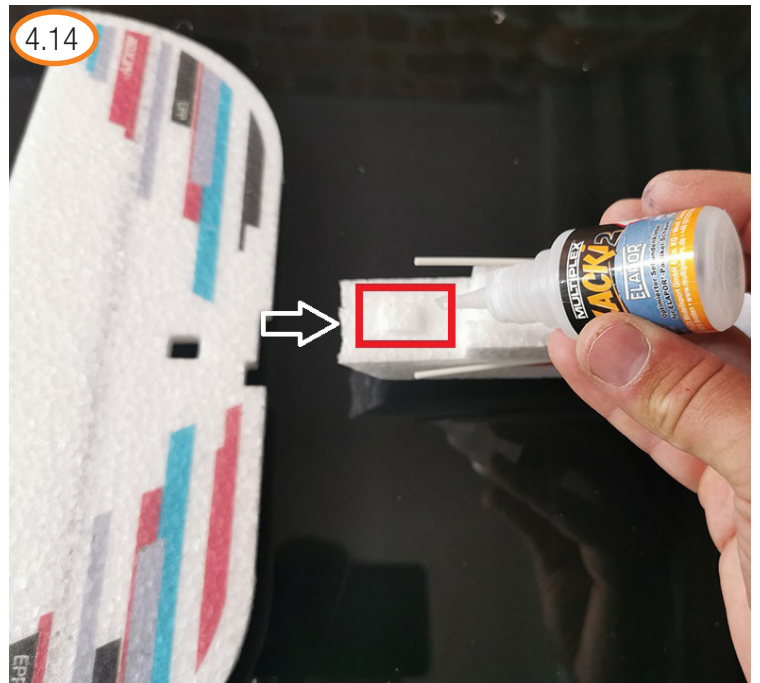
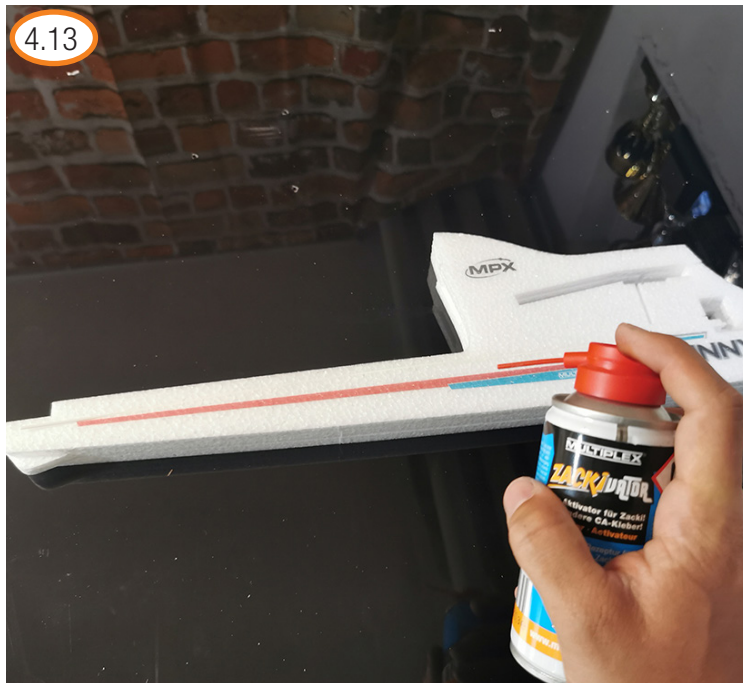
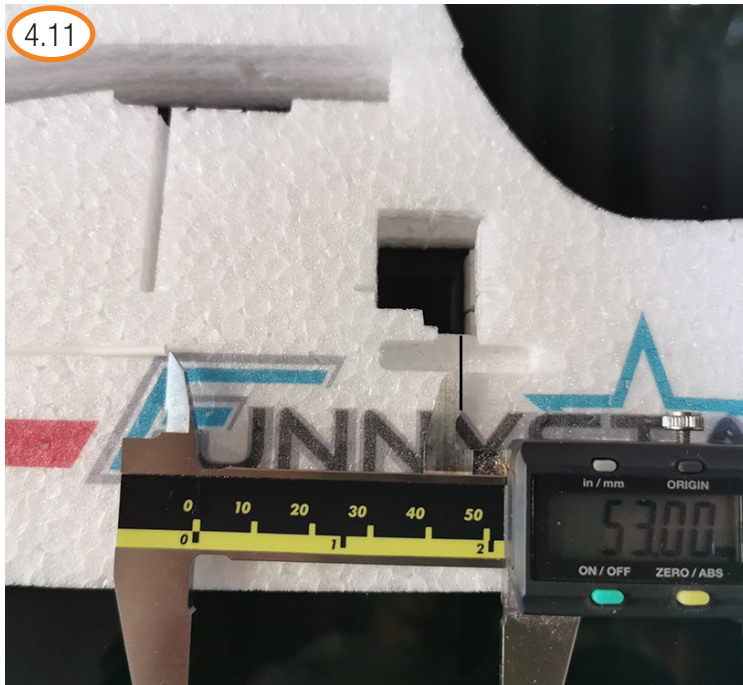



5.

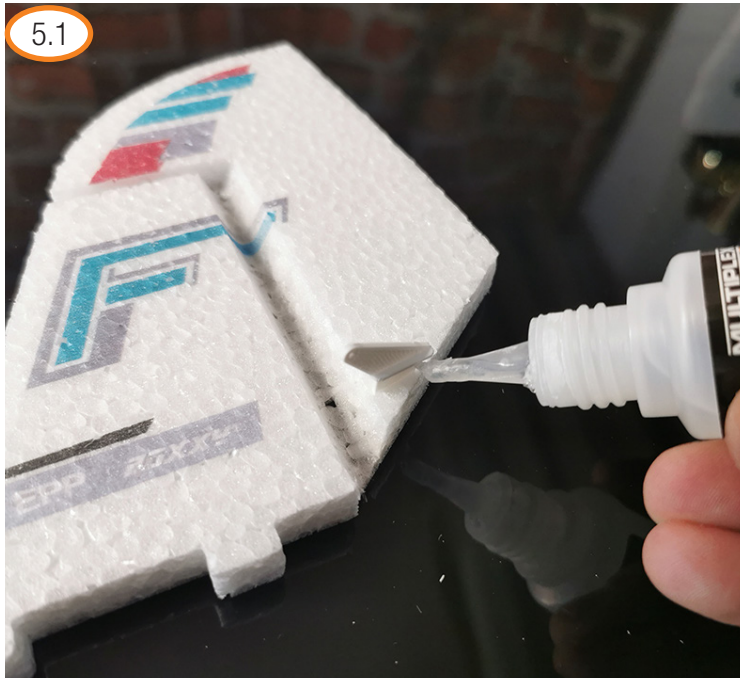
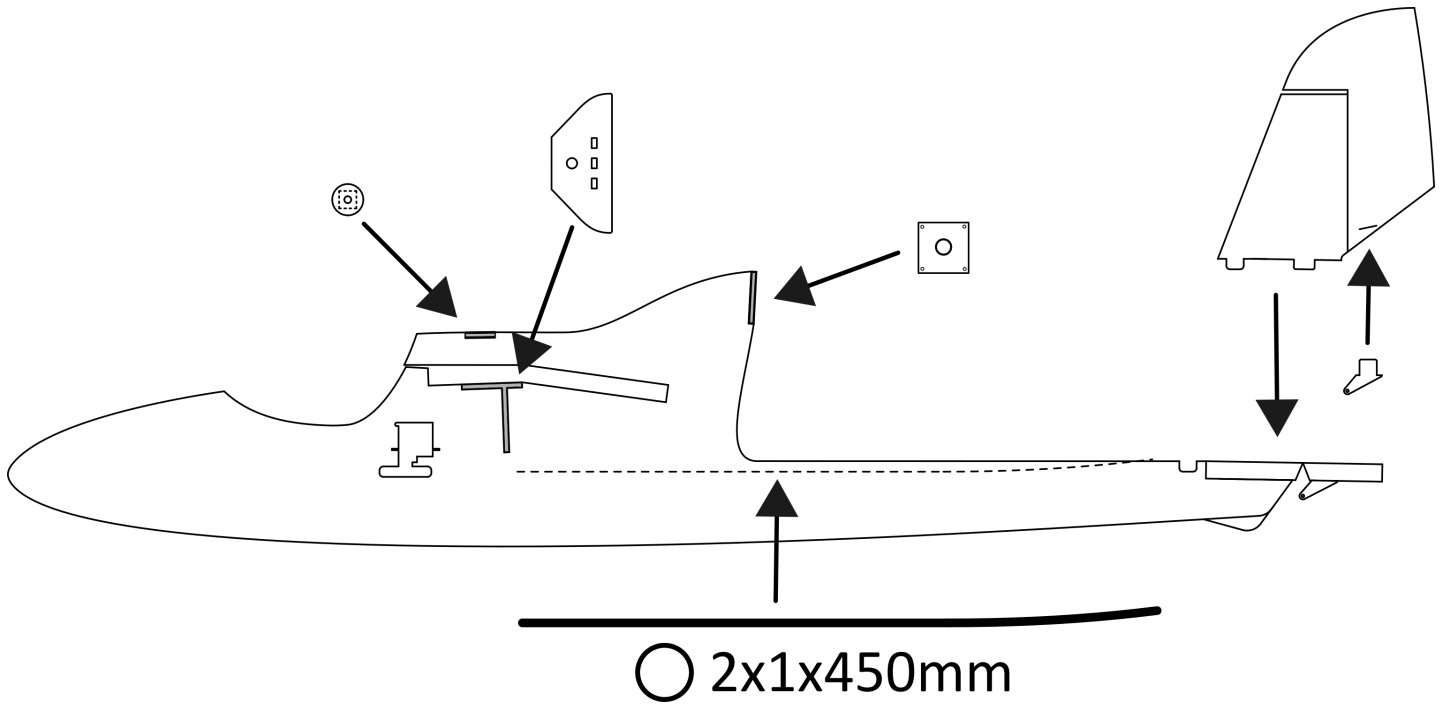

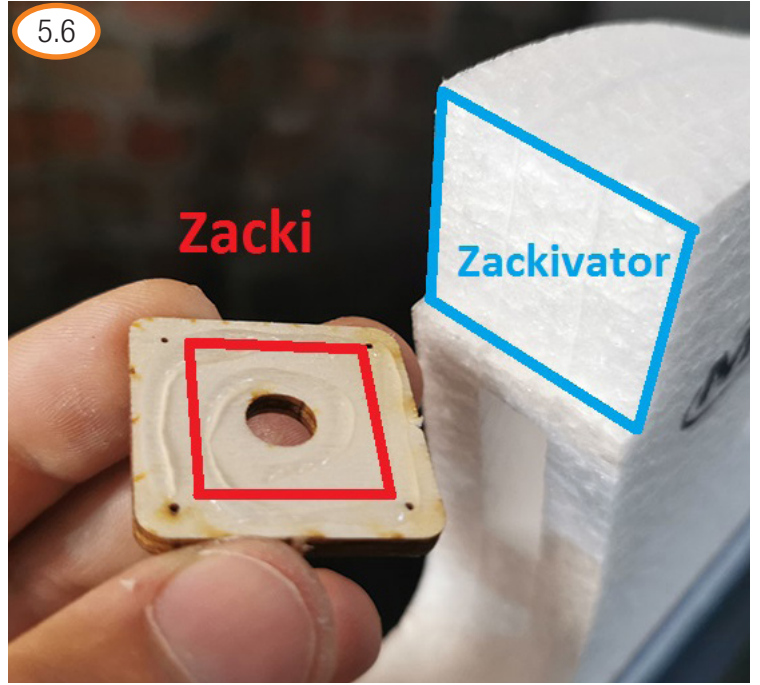
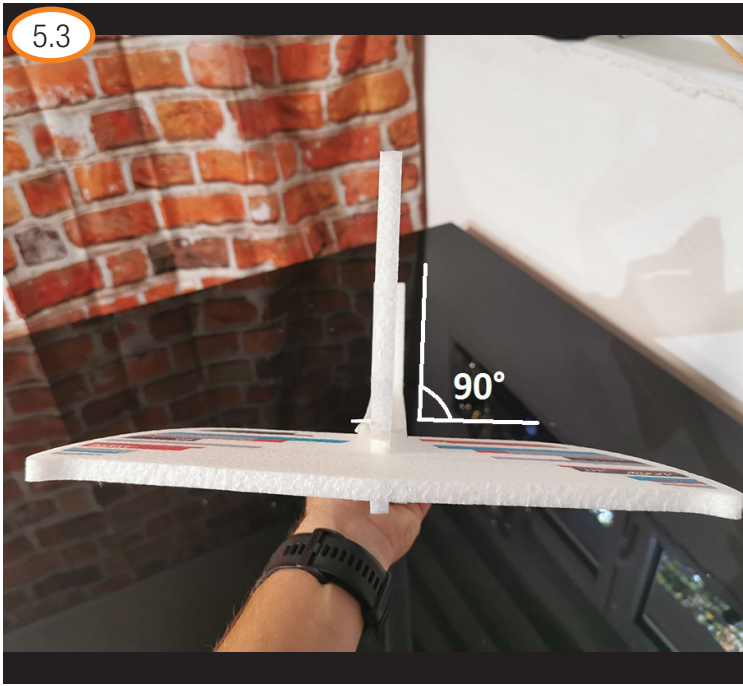



6.

● 0,8x500mm

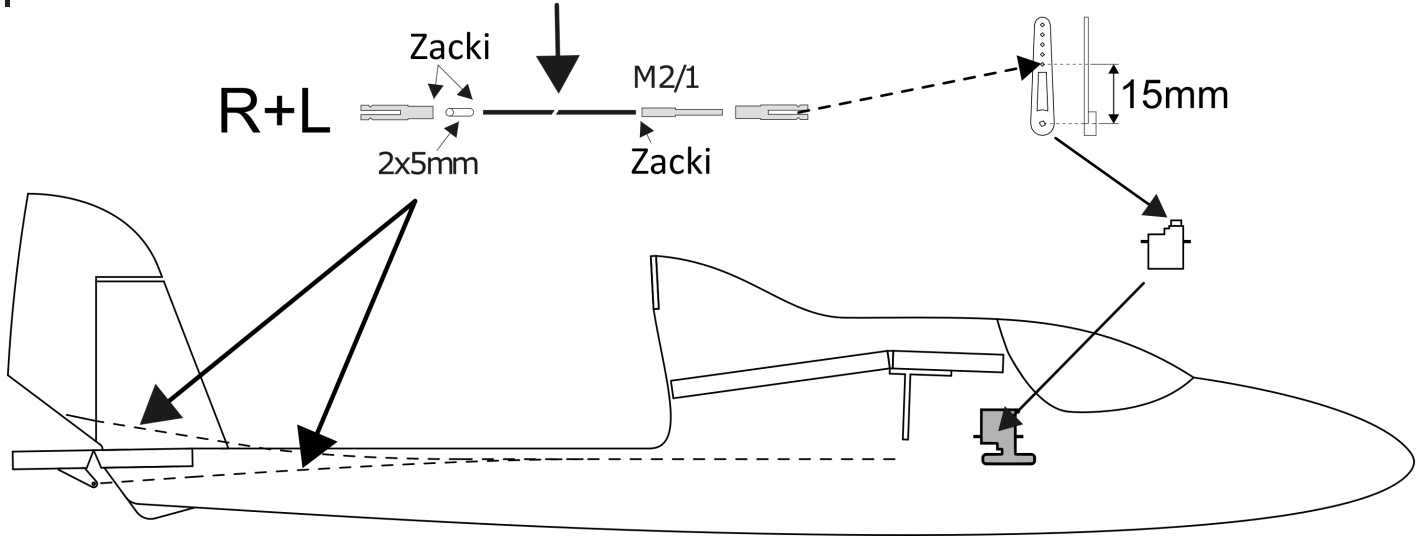

6.5



6.6



6.7



6.8

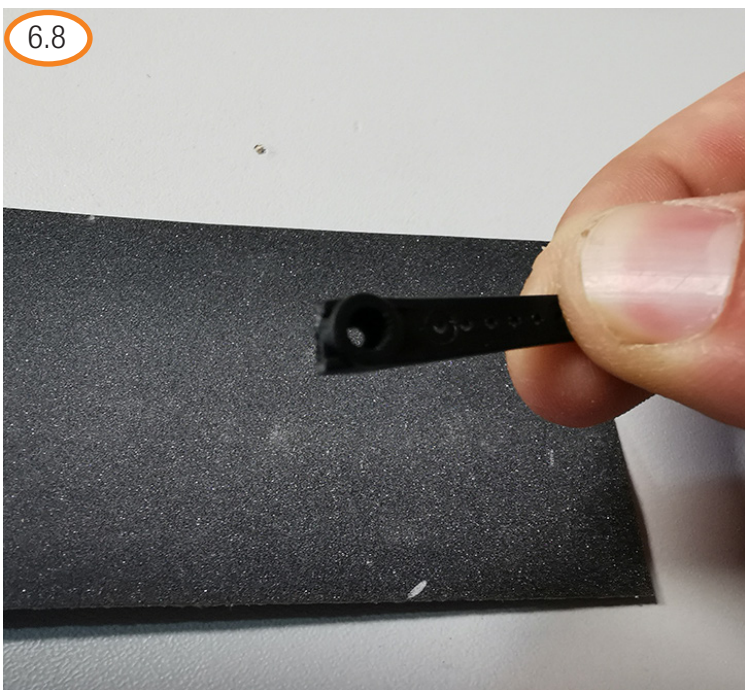

6.9



6.10



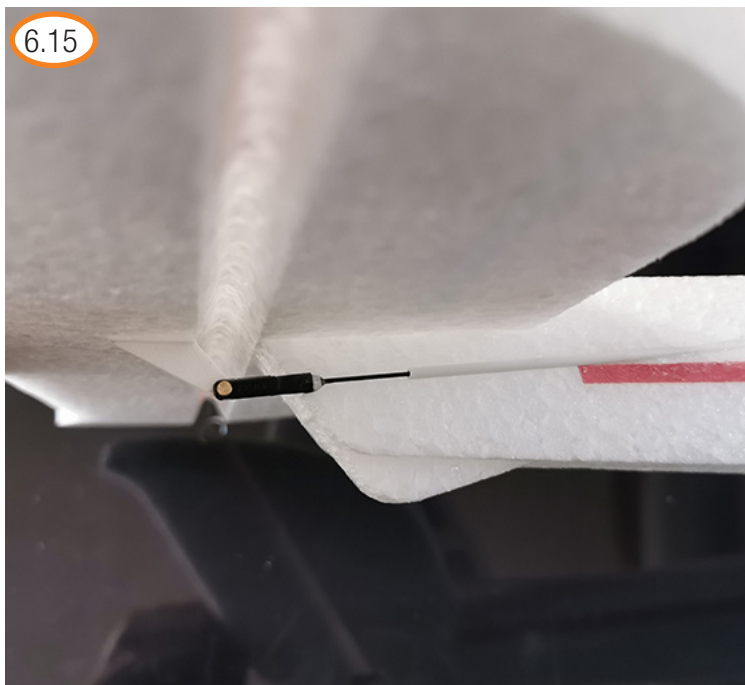

6.17



6.18

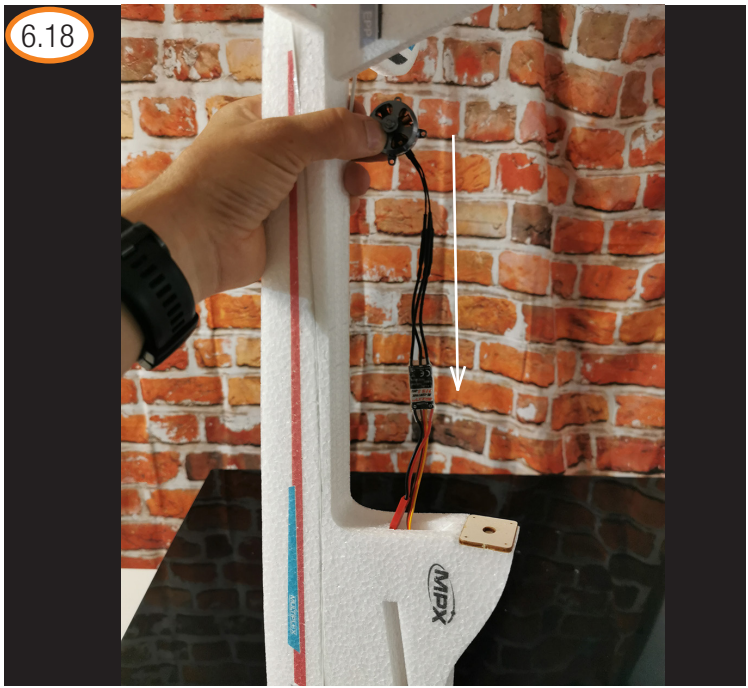

6.19



6.20



6.21

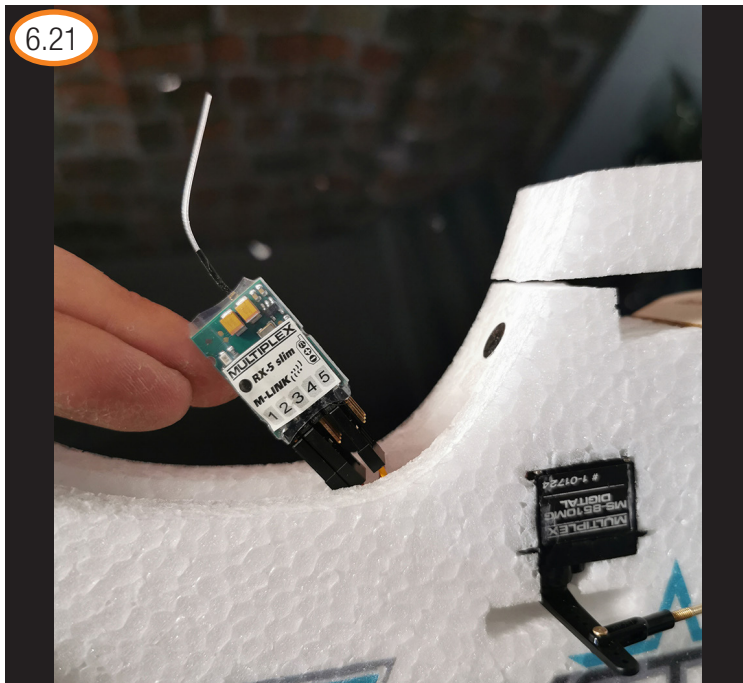

6.22



7.

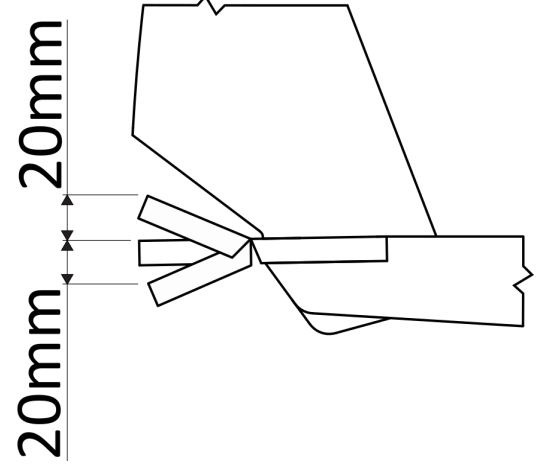
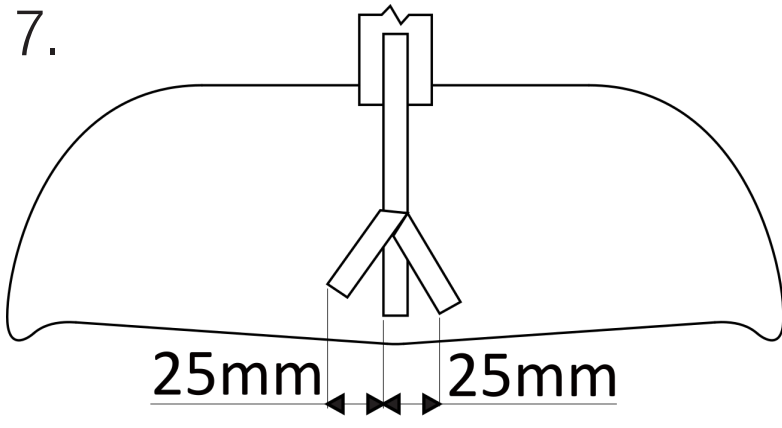

8.

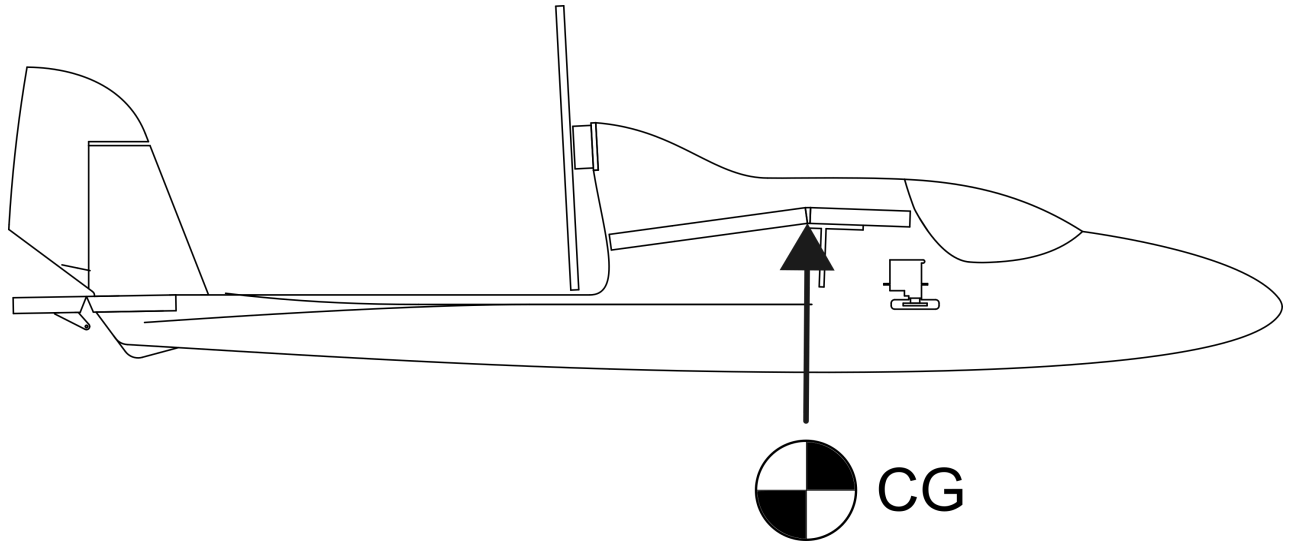



Good luck and happy landings